

# **Stormwater Standards Manual**

**Procedures & Design Criteria for  
Stormwater Management**



**CITY of GRANDVILLE  
Kent County, Michigan**

**Published By:**

**City of Grandville**  
3195 Wilson Avenue SW  
Grandville, MI 49418  
616.531.3030  
[www.cityofgrandville.com](http://www.cityofgrandville.com)

**Prepared By:**

**Fishbeck, Inc.**  
1515 Arboretum Drive SE  
Grand Rapids, MI 49546  
616.575.3824  
[www.fishbeck.com](http://www.fishbeck.com)  
Project No. 150800

**In Collaboration With:**

**Grand Valley Metropolitan Council (GVMC)**  
678 Front Avenue NW, Suite 200  
Grand Rapids, MI 49504  
616.776.3876  
[www.gvmc.org](http://www.gvmc.org)

# Table of Contents

PART I – GENERAL PROVISIONS.....	1
I. Purpose.....	1
A. Compliance with State and Federal Stormwater Mandates.....	1
B. Preferred Stormwater Management Strategies .....	2
II. Authority.....	5
A. State Law and Code of City Ordinances .....	5
B. Provisions for Requirements in Addition to Minimum Standards .....	5
III. Applicability .....	5
A. Review Required .....	5
B. Exemptions.....	5
C. Redevelopment.....	5
IV. Severability Clause.....	6
V. Adoption and Revision.....	6
VI. Fees.....	6
PART II – PROCEDURES FOR PLAN SUBMISSION AND APPROVAL .....	7
I. Submission and Approval .....	7
A. Submission .....	7
B. Staged Development.....	7
C. Submission of Construction Record Drawings (“As-builts”) .....	7
II. Stormwater Drainage Requirements.....	8
A. Drainage Plan .....	8
B. Regional Stormwater Management Facility.....	9
C. Off-site Mitigation.....	9
D. Restrictive Covenants.....	10
E. Maintenance Plan and Agreement .....	12
PART III – STORMWATER MANAGEMENT REQUIREMENTS.....	13
I. Summary.....	13
II. Standards .....	15
A. Water Quality.....	15
B. Channel Protection.....	16
C. Flood Control.....	17
D. Pretreatment.....	18
E. Hot Spots .....	19
F. Coldwater Streams .....	20
G. Watershed Policy Statements .....	20
III. Design Process .....	21
A. Identify Sensitive Areas.....	21
B. Select Source Controls .....	21
C. Size Runoff Controls .....	21
D. Confirm an Adequate Outlet.....	21
E. Select Best Management Practices (BMPs) .....	22

# Table of Contents

PART IV – STORMWATER DESIGN CRITERIA .....	24
I. Soils Investigation .....	24
A. Qualifications .....	24
B. Background Evaluation.....	24
C. Test Pit/Soil Boring Requirements .....	24
D. Highest Known Groundwater Elevation.....	25
E. Field Permeability Testing .....	25
F. Design Infiltration Rates.....	27
G. Minimum Allowable Infiltration Rate.....	28
II. Calculation Methodology .....	30
A. Calculating Runoff .....	30
B. Rainfall.....	37
C. Calculating Storage Volumes and Release Rates .....	38
D. LGROW Design Spreadsheet .....	43

## List of Tables

Table 1 – Minimum Required Stormwater Standards.....	14
Table 2 – Stormwater Hot Spots .....	19
Table 3 – Stormwater BMP Matrix .....	22
Table 4 – Minimum Number of Soil Tests Required.....	24
Table 5 – Design Infiltration Rates by USDA Soil Texture Class.....	28
Table 6 – Rational Method Runoff Coefficients (2 to 500-year rainfall frequencies) .....	31
Table 7 – Surface Retardants Coefficients.....	32
Table 8 – Curve Numbers (CNs) from TR-55.....	34
Table 9 – Runoff Coefficients for Small Storm Hydrology Method .....	36
Table 10 – Rainfall Amounts (inches) .....	37

## List of Figures

Figure 1 – USDA Soil Textural Triangle .....	29
Figure 2 – Extended Detention Hydrograph.....	39

# Table of Contents

## List of Appendices

**Appendix 1 Application and Checklists**

**Appendix 2 Watershed Policy Statements**

**Appendix 3 BMP Design Criteria for Stormwater Controls**

# Table of Contents

## List of Abbreviations

### Acronyms

ASTM	American Society for Testing and Materials
BMP	Best Management Practice
CN	Curve Number
DEQ	Michigan Department of Environmental Quality (Michigan Department of Environment, Great Lakes and Energy as of April 7, 2019)
DNR	Michigan Department of Natural Resources
EPA	United States Environmental Protection Agency
GIS	Geographic Information System
GVMC	Grand Valley Metropolitan Council
HSG	Hydrologic Soil Group
LGROW	Lower Grand River Organization of Watersheds
LID	Low Impact Development
MCL	Michigan Compiled Laws
MDOT	Michigan Department of Transportation
MS4	Municipal Separate Storm Sewer System
NAVD 88	North American Vertical Datum of 1988
NOAA	National Oceanic and Atmospheric Administration
NPDES	National Pollutant Discharge Elimination System
NRCS	Natural Resource Conservation Service
O&M	Operation and Maintenance
PA	Public Acts of Michigan
SEMCOG	Southeast Michigan Council of Governments
SESC	Soil Erosion and Sedimentation Control
TR-55	Technical Release 55
TSS	Total Suspended Solids
USDA	United States Department of Agriculture
USGS	United States Geological Survey

### List of Units

ft ( ' )	feet
in ( " )	inches
ac	acre
cfs	cubic feet per second
cft	cubic feet
hr	hour
H:V	horizontal to vertical
in/hr	inches per hour
mg/L	milligrams per liter
min	minute

# Table of Contents

## Definitions

City	City of Grandville, Kent County, State of Michigan
Design Engineer	The civil engineer who is a professional engineer licensed under Article 20 of the Occupational Code (Act 299, PA 1980) retained by the Developer to design the site plan for a plat or any other land development, including stormwater management and drainage
Developer	Any person, landowner, firm, association, partnership, corporation, or combination of any of them that holds an ownership interest in land, and who submits a site plan for drainage
Register of Deeds	The Kent County Register of Deeds
Review Engineer	The engineer appointed by the City to review the stormwater management and drainage elements of a plat or any other land development

## I. PURPOSE

The City of Grandville (City) maintains a storm sewer infrastructure that serves a majority of its jurisdictional area. As the City continues to grow and redevelop, stormwater drainage systems will be necessary to provide for public safety, convenience, and the protection of property. The future of the City's surface water and groundwater resources also depends to a great extent on the management of storm water runoff. The City takes an active role in protecting these resources through effective stormwater management planning and practices.

It is the purpose of this design criteria manual to establish a uniform set of minimum stormwater standards to meet the following objectives in accordance with the Stormwater Ordinance ([reference](#)):

1. Reduce artificially induced flood damage.
2. Minimize increased storm water runoff rates and volumes from identified new land development.
3. Minimize the deterioration of existing watercourses, culverts and bridges, and other structures.
4. Encourage water recharge into the ground where geologically favorable conditions exist.
5. Prevent an increase in non-point source pollution.
6. Maintain the integrity of stream channels for their biological functions, as well as for drainage and other purposes.
7. Minimize the impact of development upon stream bank and streambed stability.
8. Reduce erosion from development or construction projects.
9. Preserve and protect water supply facilities and water resources by means of controlling increased flood discharges, stream erosion, and runoff pollution.
10. Reduce storm water runoff rates and volumes, soil erosion, and non-point source pollution, wherever practicable, from lands that were developed without storm water management controls meeting the purposes of these standards.
11. Reduce the adverse impact of changing land use on water bodies.

### A. Compliance with State and Federal Stormwater Mandates

The National Pollutant Discharge Elimination System (NPDES) Municipal Separate Storm Sewer System (MS4) permit requires the City to adopt an ordinance or other regulatory mechanism to address post-construction stormwater runoff from new development and redevelopment projects, including preventing or minimizing water quality impacts. The City is required to obtain a permit under Section 402 of the Federal Clean Water Act, as amended, and under Water Resources Protection (Part 31, Act 451, PA 1994) of the Michigan Natural Resource and Environmental Protection Act (NREPA), as amended. The Post-Construction Storm Water Runoff Program of the MS4 permit requires among other things:

1. A water quality performance standard to ensure specified reductions in total suspended solids.
2. A channel protection performance standard to address resource impairments resulting from increases in bankfull flow rates and volumes.
3. A review procedure for the evaluation of infiltration BMPs to meet water quality and channel protection standards in areas of soil or groundwater contamination.
4. Measures to address associated pollutants in identified "hot spots," which include land uses with the potential for significant pollutant loading that could result in the contamination of surface water or groundwater, including public water supplies.
5. A long-term operation and maintenance (O&M) plan and agreement allowing for the inspection of the BMP, including a mechanism for tracking the transfer of O&M responsibility and compliance.

The minimum standards in this manual adhere to the Post-Construction Storm Water Runoff Program requirements for new and redevelopments set forth in the *State of Michigan National Pollutant Discharge*



*Elimination System Permit Application for Discharge of Storm Water to Surface Waters of the State from a Municipal Separate Storm Sewer System* (DEQ, 2013, Rev 10/2014).

## B. Preferred Stormwater Management Strategies

It is the position of the City to promote the following stormwater management strategies:

### **Alternative Approach for Channel Protection**

An alternative approach using extended detention is allowed by the City when the full channel protection volume cannot be retained onsite. These standards provide specific criteria for determining the conditions under which the alternative approach will be approved for use. A flow chart outlining this process is shown on the following page.

Off-site mitigation for channel protection is allowed where physical constraints of individual sites may preclude effective onsite treatment. Specific requirements are provided in Part 2 section “Off-site Mitigation.”

Payment-in-lieu programs are allowed in the MS4 permit, but have not been adopted by the City.

### **Regional Stormwater Management (optional)**

The management of stormwater on a regional basis is encouraged where practical, particularly where site constraints preclude effective onsite treatment of stormwater. A Regional stormwater management approach allows for the use of superior performing BMPs that require more space, and provides more flexibility for BMPs to be sited strategically to address a known water quality issue.<sup>1</sup> Specific requirements are provided in Part 2 section “Regional Stormwater Management Facility.”

### **Low Impact Development**

Onsite Low Impact Development (LID) is the preferred stormwater management strategy to meet the multiple objectives identified previously. LID uses the basic principle modeled after nature to manage rainfall where it lands. The outcome of LID is mimicking existing site hydrology by using design techniques to infiltrate, filter, store, evaporate and detain runoff close to its source. Many of these techniques incorporate the use of vegetation, and are collectively referred to as Green Infrastructure. A LID approach offers additional benefits in terms of increased property value and potential cost savings.<sup>2</sup> The size of stormwater storage facilities and infrastructure can often be reduced by incorporating LID principles into a site design up front.

The *Low Impact Development Manual for Michigan* (SEMCOG, 2008) was used to develop this manual. The standards in this manual incorporate LID principles into the design process and include design criteria for LID and small site BMPs.

---

<sup>1</sup> Maupin, Miranda, and Wagner, Theresa (2003). *Regional Facility vs. On-site Development Regulations: Increasing Flexibility and Effectiveness in Development Regulation Implementation*, City of Seattle, Seattle, Washington.

<sup>2</sup> United States Environmental Protection Agency (December 2007). *Reducing Stormwater Costs through Low Impact Development (LID) Strategies and Practices*, EPA 841-F-07-006.

Lower Grand River Organization of Watersheds MS4 Stormwater Ordinance Committee  
 Alternative Approach Flow-Chart

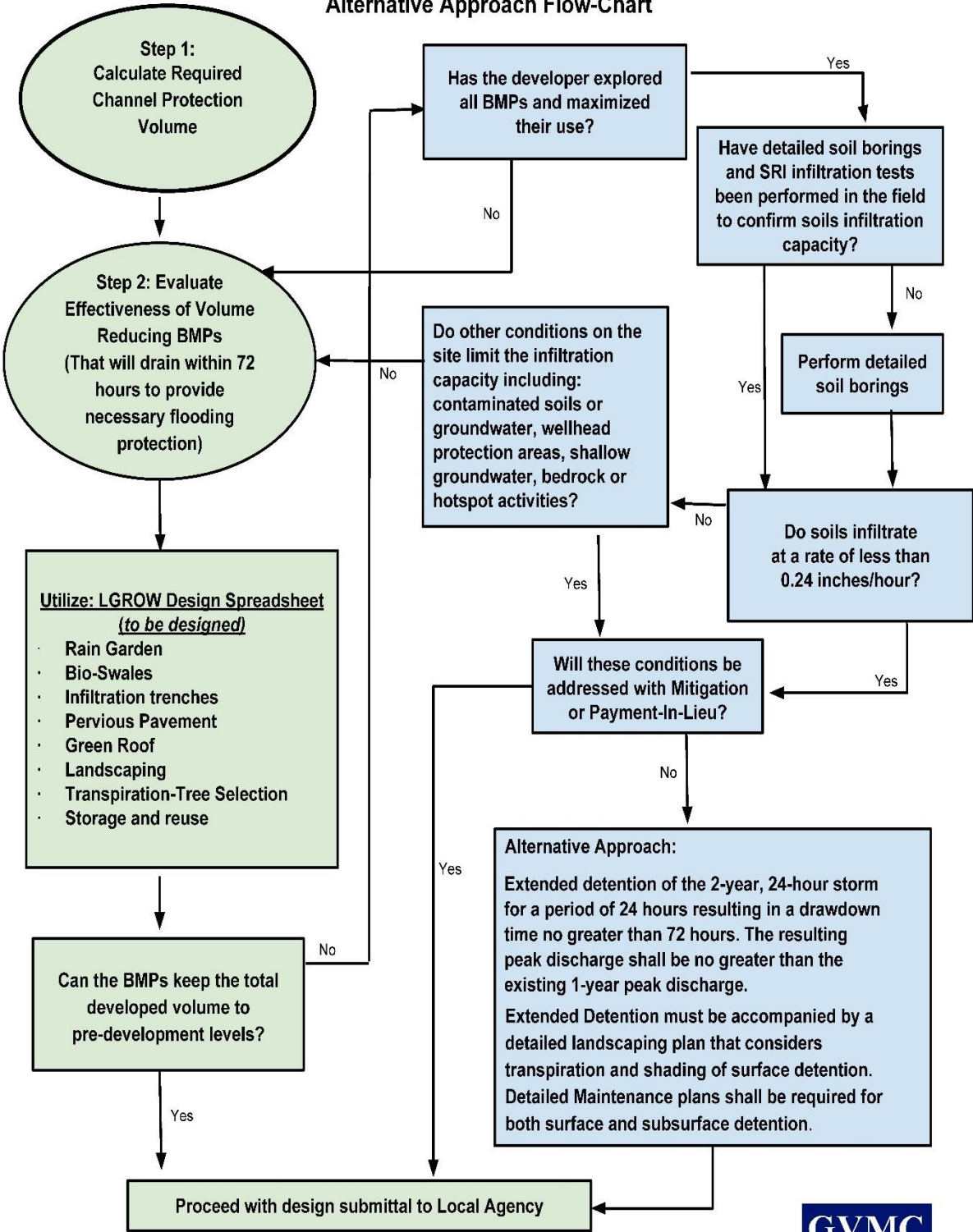

### Stormwater Management Preferred Approach Incorporates Low Impact Development (LID)



Traditional Parking Lot Design



Preferred: LID Parking Lot Design



Traditional "Big Box" Site Layout



Preferred: Equivalent LID Site Layout

## II. AUTHORITY

### A. State Law and Code of City Ordinances

Under state law (MCL 117.3(k)), the City Commission has the power to enact, amend and repeal all ordinances that may be necessary or proper for carrying out the powers conferred and the duties imposed upon the City by the charter and by the laws of the State.

The Code of City Ordinances, Chapter [REDACTED] and Chapter [REDACTED], establish the site plan review procedure under the Land Division Act (MCL 560.101 et seq.); Condominium Act (MCL 559.101 et seq.) and local regulation of condominiums (MCL 559.241); the Mobile Home Commission Act (MCL 125.2301 et seq.); and the Michigan Zoning Enabling Act (MCL 125.3101 et seq.). Chapter [REDACTED] (Stormwater Ordinance) provides for the regulation and control of stormwater runoff and establishes procedures for obtaining a stormwater permit as part of the site plan approval process. These published Stormwater Standards are incorporated by reference into the Stormwater Ordinance.

### B. Provisions for Requirements in Addition to Minimum Standards

This manual provides minimum standards to be complied with by Developers and in no way limit the authority of the City in which the development is situated to adopt or publish and enforce higher standards as a condition of approval of the final plat or site plan.

The City reserves the right to determine site-specific requirements other than those herein, based upon review of the plans. Any deviations from these standards shall be subject to approval by the City.

## III. APPLICABILITY

### A. Review Required

These standards apply to private and public development and redevelopment projects. The standards also apply to projects being completed by the City, including road projects.

The following types of developments shall be subject to review under these standards:

1. All new development and redevelopment projects, including private, commercial and public projects that disturb at least one acre or more, and projects less than one acre that are part of a larger common plan of development or sale that would disturb one acre or more, and discharge directly or indirectly into a regulated City MS4.

### B. Exemptions

The following development activities are exempt from these standards:

1. Construction of individual single and two-family residential structures.
2. Additions or modifications to existing single and two-family residential structures.

### C. Redevelopment

Redevelopment and additions requiring site plan review shall comply with the current standards for the redeveloped or newly constructed portion of the site.

The City reserves the right to require that the entire site be brought up to the current standards.

## IV. SEVERABILITY CLAUSE

If any part of these standards is found to be invalid, such invalidity shall not affect the remaining portions of the standards which can be given effect without the invalid portion, and to this end the standards are declared to be severable.

## V. ADOPTION AND REVISION

The Grandville City Council has adopted these Stormwater Standards and the Schedule of Fees [by resolution] on [Month] \_\_, 2021. Revisions to the standards or fees will be subject to review and approval by the Grandville City Council.

Revisions to the standards affecting MS4 permit requirements must be reviewed and approved by the DEQ.

## VI. FEES

The fees for reviewing a plat or site development under the provisions of the Stormwater Standards are set forth in the Schedule of Fees that can be found through the City's webpage at:

<https://www.cityofgrandville.com/departments/city-clerk/licenses-permits>

## I. SUBMISSION AND APPROVAL

### A. Submission

The following submittals are required for City review and approval in issuing a stormwater permit in addition to the site and development plan review submittals required by City ordinance:

#### Site Plan Review

1. Application for Stormwater Review in **Appendix 1**.
2. Stormwater Worksheet included in **Appendix 1** and calculations prepared by a professional engineer licensed in the State of Michigan.
3. Drawings. Two (2) prints and one (1) electronic file (.pdf) of the preliminary plat, site plan, or construction drawings containing the information on the Stormwater Review Checklist in **Appendix 1**.
  - a. Preliminary plat: Prepared by a professional engineer or surveyor licensed in the State of Michigan.
  - b. Construction drawings: Sealed by a professional engineer licensed in the State of Michigan.
4. Applicable fee (refer to Part 1 section "Fees").
5. Other required documentation on the Submittal Checklist included in **Appendix 1**.

### B. Staged Development

Should the Developer plan to develop a given area but wish to begin with only a portion of the total area, the original preliminary plat or site plan shall include the proposed general layout for the entire area. The first phase of the development shall be clearly superimposed upon the overall plat or site plan in order to illustrate clearly the method of development that the Developer intends to follow. Each subsequent plat or site plan shall follow the same procedure until the entire area controlled by the Developer is developed.

Final acceptance by the City of only one portion or phase of a development does not ensure final acceptance of any subsequent phases or the overall general plat or site plan for the entire area; nor does it mandate that the overall general plat or site plan be followed as originally proposed, if deviations or modifications acceptable to the City are proposed.

### C. Submission of Construction Record Drawings (“As-builts”)

One (1) paper copy and one (1) electronic file meeting GIS digital submission requirements (refer to Stormwater Review Checklist in **Appendix 1**) shall be submitted to the City with a letter of certification by the Design Engineer for all developments reviewed under these standards. Construction record drawings must be submitted prior to release of any review deposit.

At a minimum, construction record drawings shall contain the information listed on the Stormwater Review Checklist (**Appendix 1**). The City shall have thirty (30) days to review construction record drawings.

## II. STORMWATER DRAINAGE REQUIREMENTS

### A. Drainage Plan

#### Drainage Patterns

Proposed drainage for the development shall conform to existing watershed boundaries, natural drainage patterns within the site, or any established county drainage districts.

#### Staged Development

Each phase shall be self-sufficient from the standpoint of drainage.

#### Location of Stormwater Management Facilities

Stormwater management facilities within a development planned to have multiple lot owners shall be located on dedicated outlots, within road rights of way, or have separate easements granted to the entity responsible for operation and maintenance of the stormwater management system.

Parking lots and pedestrian traffic areas shall not be flooded for use as stormwater detention.

#### Offsite Stormwater

Surface water flows from offsite land shall be routed around the development's onsite stormwater system whenever possible. An onsite detention basin shall not be used to pass this flow through the site. If water from offsite is directed through an onsite detention basin, the basin must either be designed as a regional stormwater management facility, or detain the existing offsite water to the same flood control standard as the site.

#### Stormwater Discharge

The rate, volume, concentration, or constitution of stormwater discharged from a site shall not create adverse impacts to downstream property owners and watercourses.

1. Post-development discharge shall not exceed the capacity of the existing infrastructure or the existing discharge rate from the site.
2. Post-development discharge shall not cause adverse impact to offsite property due to concentrated runoff or ponded water of greater height, area, and duration.
3. Discharge shall not cause downstream erosion or sedimentation.
4. For a downstream drainage system that is inadequate to handle any increase to the existing design discharge from the site development, it is the Developer's responsibility to:
  - a. Stabilize or upsize the existing conveyance system, or establish a county drain to provide the needed design level of flood protection.
  - b. Obtain flooding easements for measurable increases in water levels determined to cause an adverse impact.
  - c. Provide additional onsite stormwater controls.
5. Discharge to groundwater shall not cause groundwater mounding sufficient to adversely impact structures or adjacent property.
6. Post-development discharge shall not cause downstream impairments by the contribution of pollutants.
7. Post-development discharge shall not cause downstream impairments to coldwater streams due to thermal properties of the discharge.

It is the Developer's obligation to meet this standard. Should a stormwater system, as built, fail to comply with the standards herein, it is the Developer's responsibility to have constructed at their expense, any necessary additional and/or alternative stormwater management facilities. Such additional facilities will be subject to the City's review and approval.

## B. Regional Stormwater Management Facility

Regional stormwater management facilities are designed to serve multiple developments or parcels with more than one property owner at the time of development or redevelopment.

The City may pursue projects to construct facilities to serve a particular stormwater management district, or may approve facilities proposed to be constructed by individual Developers. City facilities (if any) are identified in the Watershed Policy Statements in **Appendix 2**. Private facilities must have a written agreement between responsible parties with recorded easements to ensure operation and maintenance of the facility in perpetuity. Agreements must specify maximum allowable runoff coefficients for each parcel contributing to the facility.

The regional facility should be constructed first, prior to any development or redevelopment. Written approval is required from the City if construction is to be delayed. Financial surety and temporary onsite measures must be provided until the facility is constructed.

## C. Off-site Mitigation

Off-site mitigation refers to stormwater management practices implemented at a location other than the proposed development or redevelopment, but within the same jurisdiction and sewershed to meet channel protection standards required by the MS4 permit. The watershed is the area represented by the MDEQ, 10-digit Hydrologic Unit Code. The sewershed is the area where storm water is conveyed by an MS4 to a common outfall or point of discharge. The City also requires that the off-site mitigation is protective of the same watercourse or waterbody to which the site discharges, and is located downstream of the proposed development or redevelopment if possible.

### Criteria

The determination to approve off-site mitigation will be based on multiple criteria and not solely on the difficulty or cost of implementing BMPs on site. Conditions under which the option to move off site would become available may include:

1. Limited size of the lot outside of the building footprint to create the necessary infiltration capacity even with amended soils.
2. Soil instability as documented by a thorough geotechnical analysis.
3. A site use that is inconsistent with capture and reuse of stormwater.
4. Too much shade or other physical conditions that preclude adequate use of plants.
5. The potential water quality impact from the original project site and the benefits realized at the off-site location.

The City may approve off-site mitigation if the Developer demonstrates that site constraints preclude sufficient treatment and restoration of hydrology onsite, and the following minimum requirements are met:

1. Offset ratio. The offset ratio for the amount of storm water not managed onsite in relation to the amount of stormwater required to be mitigated at another site is as follows:
  - a. First Tier: Manage a minimum of 0.4 inches of storm water runoff onsite, and provide a 1 to 1.5 offset ratio for the remaining amount of storm water managed offsite.
  - b. Second Tier: If it completely infeasible to manage the minimum onsite, provide a 1 to 2 offset ratio for the amount of storm water managed offsite.
2. Schedule. Offsite mitigation shall be completed within 24 months after the start of the original site construction.
3. Assurances. Offset projects shall be preserved and maintained in perpetuity through the procedures and tracking system administered by the City.



## D. Restrictive Covenants

For plats and site condominiums, a copy of restrictive covenants or master deed language related to drainage shall be provided to the City along with construction drawings for approval. Covenants and deeds shall be recorded at the Register of Deeds prior to release of posted surety.

### Block Grading Plan

A block grading plan shall be incorporated in the restrictive covenants of the plat or master deed to ensure proper drainage of individual lots. In addition, the Developer shall provide a copy of the block grading plan to the City for their permanent files. The block grading plan shall include the Lowest Allowable Floor Elevation and Lowest Allowable Opening Elevation for each lot, and include the “basement type” for each lot (e.g. walkout, daylight, or standard basement) as indicated by the topography of each site and according to the approved design plans. The block grading plan shall state:

*The block grading plan shows the direction of flow for the surface drainage for all lots. It is the lot owner’s responsibility to ensure that the final grading of the lot is in accordance with the block grading plan. During the final lot grading and landscaping, the owner shall take care to ensure that the installation of fences, planting, trees, and shrubs do not interfere with nor concentrate the flow of surface drainage. No changes will be made in the grading of any lot areas used for drainage which would later affect surface runoff drainage patterns without the prior written consent of the City of Grandville for all portions of the drainage system. Finish grading for home construction shall be completed in conformance with the master drainage plan for the development and in such a manner so as not to create the excessive ponding of stormwater on the sites within the development.*

### Minimum Floor and Opening Elevations

Minimum building floor and opening elevations shall be established to eliminate the potential of structural damage and flooding of building interiors. A certification by the Design Engineer that the minimum floor and opening elevations do not pose a risk of flooding for up to the 100-year storm shall be provided for each development or phase of development prior to approval. Documentation to support allowable minimum floor and opening elevations shall be submitted with construction drawings.

#### Criteria for determining the Lowest Allowable Floor Elevation

1. Proximity to detention/retention facilities due to groundwater mounding (which may not be apparent until after construction).
2. Groundwater elevations from monitor wells, test pits and/or soil borings including any soil mottling noted in the soil profile.
3. Regional and cyclical groundwater levels available online.
4. Hydrogeologic studies and groundwater modeling.

#### Criteria for determining the Lowest Allowable Opening Elevation

1. Proximity to open drain or natural watercourse, pond or wetland and the 100-year flood elevation.
2. Proximity to detention/retention basin and design high water level.
3. Proximity to drainage swales and/or flood routes designed to convey the 100-year storm event runoff including overflows from detention/retention basins.
4. Proximity to an enclosed storm sewer system with open ends or catch basins that could surcharge during the 100-year storm event.
5. Type of building foundation (e.g. walkout, daylight, or standard basement) as dictated by the topography of each site.

Minimum floor and opening elevations shall be incorporated in the restrictive covenants of the plat or master deed, including bench mark references. It is the responsibility of the Developer to provide a sufficient number of bench marks (NAVD 88 datum) to use as a reference for establishment of minimum floor and opening elevations for all lots. Lots not impacted by high groundwater or potential flooding from a 100-year storm event as determined by the Design Engineer shall be so noted as well. The restrictive covenant shall state:

*The lowest allowable floor elevations are set at 2-foot or more above the highest known ground water elevation. The lowest allowable floor and/or opening elevations are set 1-foot or more above the 100-year floodplain or design high water level of the stormwater system. These elevations are set to reduce the risk of structural damage and the flooding of building interiors. A waiver from the set elevations may be granted by the City of Grandville following receipt of a certification for a professional engineer licensed in the State of Michigan demonstrating that the proposed elevation does not pose a risk of flooding. Minimum building floor and opening elevations and bench mark locations and elevations are indicated on the Block Grading Plan.*

### **Footing Drains and Sump Pumps**

Provide direction in the restrictive covenants of the plat or condominium master deed for footing drain and sump pump outlets. If proposed to be directed to the storm sewer system, the restrictive covenant shall state:

*Water from such sources as eave troughs and footing drains shall be directed to footing drain laterals provided for the lots. Water from footing drains shall be discharged to the lateral via a sump pump with check valve system, or a gravity system with a double flap gate valve for backflow prevention. If no lateral is provided, the lot owner shall discharge said water in such a manner as to not impact neighboring land or public streets.*

*Floor drains, laundry facilities or other similar features shall not be connected to a footing drain or sump pump system discharging to footing laterals and the storm sewer system. Laundry facilities and sewage lift pumps must discharge into the sanitary sewage disposal system.*

### **Easements for Side Yard and Surface Drainage**

Private easements for enclosed yard drains and surface drainage are for the benefit of upland lots within the development or upland sites that currently drain across the proposed plat or site. Language shall be included within the restrictive covenants of the plat or condominium master deed that clearly notifies property owners of the location and purpose of private easements for side yard and surface drainage, as well as restrictions on use or modification of these areas. A separate, recordable easement form is not required. The restrictive covenant shall state:

*Private easements for side yard and surface drainage are for the benefit of upland lots within the subdivision and any improper construction, development, or grading that occurs within these easements will interfere with the drainage rights of those upland lots. Private easements for surface drainage are for the continuous passage of surface water and each lot owner will be responsible for maintaining the surface drainage system across their property. No construction is permitted within a private easement for side yard and surface drainage. This includes fences, swimming pools, sheds, garages, patios, decks, or any other permanent structure or landscaping features. No dumping of grass clippings, leaves, brush or other refuse is allowed within a drainage easement. These items obstruct drainage, restrict flow and plug culverts. This can lead to higher maintenance costs and cause flooding situations.*

**Soil Erosion and Sedimentation Control Permits**

It is the responsibility of the Developer to contact the Kent County Road Commission to determine which lots if any need Soil Erosion and Sedimentation Control Permits. The restrictive covenant shall state:

*Each individual lot owner will be responsible for the erosion control measures necessary on their lot to keep loose soil from their construction activities out of the street, catch basins, and off of adjacent property. If any sedimentation in the street, catch basins, or adjacent lots results from construction for a particular site, it is the responsibility of that lot owner to have this cleaned up. This applies to ALL lot owners.*

*A Soil Erosion and Sedimentation Control Permit must be obtained from the Kent County Road Commission prior to excavation for lots \_\_\_\_\_ through \_\_\_\_\_. All conditions set forth by permit shall be met throughout construction activity until permit is allowed to expire.*

**Responsibility for Maintenance of Open Water Bodies**

The restrictive covenant shall state:

*Lot owners are responsible for the management and maintenance of open water bodies for aesthetics, aquatic habitat, recreation and water quality, including liability and costs.*

**E. Maintenance Plan and Agreement**

A legally binding maintenance agreement between the Developer and the City shall be required before approval is granted within the urbanized area. The maintenance agreement shall include a maintenance plan and schedule, and requires tracking of compliance. Contact the City for necessary forms, documents and compliance process. A copy of the recorded maintenance agreement must be presented to the City prior to construction drawing approval and release of any review deposit.

A maintenance agreement will also be required for site developments located outside of an urbanized area.

## I. SUMMARY

The following stormwater management requirements comply with the City's Stormwater Ordinance and NPDES MS4 permit and shall apply to all new and redevelopments in the City of Grandville:

1. Protection. The design process shall begin by identifying environmentally sensitive areas located on the site and laying out the site to maximize protection of the sensitive areas.
2. Source Controls. Non-structural BMPs shall be used for protection of environmental sensitive areas on the site, and to reduce the amount of stormwater runoff.
3. Runoff Controls. Stormwater runoff shall be managed onsite using structural BMPs to protect both water resources and real property. Stormwater standards are summarized in [Table 1](#). Higher standards may be required for sites that discharge to areas with known issues.
4. Offsite Stormwater Management Options. Regional stormwater management facilities are encouraged, particularly where site constraints preclude effective onsite treatment of stormwater. Off-site mitigation may be approved to meet channel protection performance standards.
5. Watershed Policy Statements. Specific stormwater management policies have been established for identified watersheds and are required to be met in addition to these minimum standards (**Appendix 2**).
6. Adequate Outlet. The design maximum release rate, volume or concentration of stormwater discharged from a site shall not exceed the capacity of the downstream stormwater infrastructure or cause impairment to the offsite receiving area.
7. BMP Design. BMPs must be designed to meet the minimum criteria provided. BMPs selected to meet the water quality treatment standard must also be shown to reduce total suspended solids (TSS) in stormwater runoff by at least 80% or to a concentration of no greater than 80 mg/L (refer to [Table 3](#)).
8. Groundwater. The highest known groundwater elevation and extent of mounding from infiltration BMPs shall be determined to ensure no adverse impacts internal and external to the development.
9. Soils. Test pits or soil borings and field permeability testing are required for most structural BMPs to determine soil classification, depth to groundwater, infiltration rates, and the presence of other site constraints.
10. Restrictive Covenants. Plats and site condominium developments must incorporate specific requirements for lot grading, minimum floor and opening elevations, footing drains, private easements for side yard drainage, and individual soil erosion and sedimentation control (SESC) permits.
11. Operation and Maintenance. Stormwater BMPs must be designed to allow for operation and maintenance, demonstrated in the review submittals. A maintenance agreement between the Developer and the City is required for private stormwater management systems. A maintenance plan and compliance tracking is required as part of the maintenance agreement.

**Table 1 – Minimum Required Stormwater Standards**

Standard/Where Required	Criteria
<b>Water Quality</b> “first flush” All sites.	<p>Treat the runoff generated from 1 inch of rain over the project site (i.e. the 90% annual nonexceedance storm) through BMPs designed to reduce post-development TSS loadings by 80%, or achieve a discharge concentration not to exceed 80 mg/L.</p> <p>Treatment may be provided through settling (permanent pool or detention), filtration or infiltration, absorption, or chemical/mechanical treatment.</p>
<b>Channel Protection</b> Surface water discharges	<p>Retain onsite the increase between the pre-development and post-development runoff volume and rate for all storms up to and including the 2-year, 24-hour rainfall event; OR</p> <p>Where site conditions preclude infiltration, an alternative approach may be allowed after all other onsite retention options are maximized: Extended Detention of the 2-year, 24-hour storm for a period of 24 hours resulting in a drawdown time no greater than 72 hours. The resulting peak discharge shall be no greater than the existing 1-year peak discharge.</p> <p>Pre-development is defined as the last land use prior to the planned new development or redevelopment.</p>
<b>Flood Control</b> All sites; unless exception is allowed.	<p>Collection and Conveyance: Design storm sewers and swales for the 10-year storm, and open channels for the 25-year storm.</p> <p>Detention and Retention: Store runoff from the 100-year storm with a maximum release rate of 0.13 cfs per acre.</p> <p>Overflow Routes for Extreme Flood: Identify overflow routes and the extent of high water levels for the 100-year flood to ensure no adverse impacts offsite or internal to the site. Where overland flow routes do not exist, detention/retention basins shall be increased in size to store a total of 2 times the flood control volume.</p> <p>Pre-development is defined as the last land use prior to the planned new development or redevelopment.</p>
<b>Pretreatment</b> Refer to <a href="#">Table 3</a> .	Forebay volume equal to 15% of water quality volume (required for detention/retention basins); Vegetated Filter Strip; Vegetated Swale; Water Quality Device.
<b>Hotspot</b> Industrial and commercial land uses in <a href="#">Table 2</a> ; Part 201 and Part 213 sites.	<p>Isolate transfer and storage areas to minimize need for treatment.</p> <p>Pretreatment BMP with impermeable barrier above groundwater and provisions for the capture of oil, grease, and sediments. Minimum spill containment volume: 400 gallons.</p>
<b>Coldwater Streams</b>	Incorporate strategies to promote groundwater recharge and/or reduce temperature of surface discharge water.

## II. STANDARDS

### A. Water Quality

#### Where Required

Treatment of the water quality volume is required for all sites to capture and treat the “first flush” of stormwater runoff that typically carries with it the highest concentration of pollutants.<sup>3</sup>

#### Standard

Capture and treatment of the runoff from the 90% annual nonexceedance storm is required for the project site. This storm is approximately equivalent to 1 inch of rain (1.00 inch for Michigan Climatic Zone 8 per DEQ memo “90 Percent Annual Nonexceedance Storms” dated March 24, 2006).

Treatment of the runoff volume from the 90% annual nonexceedance storm with properly designed BMPs to reduce TSS loading by 80%, or achieve TSS discharge concentrations not to exceed 80 mg/L, is required by the MS4 permit.

*Note:* TSS is a surrogate for other pollutants normally found in stormwater runoff. Control of TSS to meet this requirement is expected to achieve control of other pollutants to an acceptable level that protects water quality.

Natural areas of the site left undisturbed and BMPs that provide water quality treatment need not be included in the calculations. This effectively results in the directly connected impervious areas and disturbed pervious areas of the site being used to calculate the water quality volume.

#### Treatment BMPs

Selected BMPs must meet the 80% TSS reduction target either alone or in combination. Pollutant (TSS) removal efficiencies for BMPs are provided in [Table 3](#). Water quality volume can be provided through one of the following methods:

1. Settling (Permanent Pool or Detention)
2. Filtration
3. Infiltration
4. Absorption
5. Chemical/Mechanical Treatment

Permanent Pool. The volume of a permanent pool incorporated into a stormwater BMP and sized at 2.5 times the water quality volume.<sup>4</sup> This is the volume below the ordinary static water level (also known as dead storage).

Detention. The storage volume provided by detention of stormwater. Extended detention is defined as holding the stormwater runoff volume and releasing it gradually over a period of 24 hours with a drawdown time no greater than 72 hours.

Filtration. The volume of stormwater runoff routed through a BMP that provides filtration (i.e. an underdrained BMP). In the case of a vegetated filter strip or vegetated swale, the filtering area must meet minimum standards for slope, length, drainage area and vegetative cover.

Infiltration. The volume of stormwater runoff infiltrated into the ground through a stormwater BMP.

Absorption and Chemical/Mechanical Treatment. The volume of stormwater runoff routed through a proprietary water quality device.

<sup>3</sup> Stenstrom, Michael K. and Kayhanian, Masoud (2005). *First Flush Phenomenon Characterization*. California Department of Transportation, Sacramento, California.

<sup>4</sup> Barrett, Michael (2005). *BMP Performance Comparisons: Examples from the International Stormwater BMP Database*, Center for Research in Water Resources, PRC#119, University of Texas, 2005 Water Environment Federation.

## B. Channel Protection

### Where Required

Channel protection is required for surface water discharges.

### Standard

The post-development runoff rate and volume shall not exceed the pre-development rate and volume for all storms up to and including the 2-year, 24-hour storm. Onsite retention of the volume increase is required.

Retention can be provided through infiltration, or interception and evapotranspiration or reuse.

Pre-development is defined as the last land use prior to the planned new development or redevelopment.

### Alternative Approach

Where site constraints limit infiltration, and field permeability testing has confirmed the limits of the infiltration rate, an alternative approach may be allowed after all other onsite design and retention options are maximized. A flowchart detailing the alternative approach method is displayed in Part 1 section I.B. A Stormwater Worksheet (**Appendix 1**) signed by the Design Engineer must be submitted for approval before the alternative approach can be used. Site constraints that limit the use of infiltration may include:

1. Poorly draining soils (<0.24 inches per hour; typically hydrologic soil groups C and D).
2. Bedrock.
3. High groundwater, or the potential of mounded groundwater to impair other uses.
4. Wellhead protection areas.
5. Stormwater hot spots.
6. Part 201 and Part 213 sites, and areas of soil or groundwater contamination.

Conditions can be addressed with off-site mitigation, the alternative approach, or a combination of these options as the City sees fit, only if the use of all other BMP's has been maximized.

The alternative approach shall consist of extended detention of the 2-year, 24-hour storm for a period of 24 hours resulting in a drawdown time no greater than 72 hours. The resulting peak discharge shall be no greater than the existing 1-year peak discharge.

*Note:* A developed peak discharge no greater than the existing 1-year peak discharge will meet the MS4 permit requirement of not exceeding the pre-development discharge rate for all storms up to and including the 2-year storm.

If the allowable opening size from an extended detention basin becomes too small for practical design (less than 4 inches), an underdrained bioretention BMP (e.g. bioretention/rain garden, planter box, water quality swale) may be used to protect the orifice.

*Note:* Various studies have shown that underdrained biofiltration BMPs provide a significant percentage of volume reduction (23% to 73% for 25<sup>th</sup> and 75<sup>th</sup> percentiles),<sup>5</sup> and a large percentage of rate reduction (80% or more).<sup>6</sup>

---

<sup>5</sup> Geosyntec Consultants and Wright Water Engineers, Inc. (May 2012). *International Stormwater Best Management Practices (BMP) Database, Addendum 1 to Volume Reduction Technical Summary (January 2011), Expanded Analysis of Volume Reduction in Bioretention BMPs.*

<sup>6</sup> University of New Hampshire Stormwater Center (2007). *2007Annual Report.*

## C. Flood Control

### Where Required

Flood control is required for all sites.

### Standard

Detention or retention of the 100-year storm with a maximum release rate of 0.13 cfs per acre is required.

*Note:* The 100-year storm is selected to further decrease flood risk when reviewed against the economics from federal studies comparing the cost of flood damage to storm return interval.<sup>7</sup> The release rate of 0.13 cfs per acre is selected to be generally protective of floodplains in downstream watercourses and is based on result found in previous hydrologic studies on West Michigan streams.<sup>8</sup> Where volume control is not provided, an extremely low release rate is required to prevent an increase in peak flow rates in downstream watercourses or storm sewers. The increased volume and prolonged duration of runoff from multiple detention basins can have a cumulative effect to increase peak flow rate and duration in downstream reaches.

An alternate peak discharge may be allowed under certain conditions, including, but not limited to:

1. Sites located in a watershed with a non-mandated detention zone, or a regional stormwater management facility as dictated by the Watershed Policy Statement (**Appendix 2**).
2. Redevelopment sites discharging to a City storm sewer where the City has determined the sewer has adequate capacity for the existing peak runoff rate from the site. Detention need only be provided for any increase in impervious area.
3. Direct discharges to waterbodies or watercourses where the Developer demonstrates that the receiving waters possess capacity to convey the post-development discharge safely and with no negative downstream impacts due to increased flow rates, water levels or velocities. In addition, the peak flow of the receiving waters cannot be increased by the proposed development (i.e. there is a sufficient difference in the timing of the two hydrographs).
4. When the site is located adjacent to or within a floodplain, excavation of new floodplain in lieu of standard stormwater detention may be required. The excavated volume shall be equal to the standard detention basin storage volume. Only the volume above the 2-year and below the 100-year floodplain elevation can be counted to meet the volume requirement.

### Overflow Routes for Extreme Flood

Overflow routes and the extent of high water levels for the 100-year flood shall be identified for the site and for downstream areas between the site and the nearest acceptable floodway or outlet. Provisions shall be made to ensure no adverse impacts offsite or internal to the site. Where acceptable overflow routes do not exist, detention/retention basins shall be increased in size to store a total of 2 times the flood control volume.

*Note:* The intent of the extreme flood criteria is to prevent flood damage from large but infrequent storm events by identifying and/or designing overland flow paths that are clear of structures and have grades below the lowest openings of structures. Overflow routes may include floodplains along open channels, overbank areas along vegetated swales, curb jumps in drives and parking lots, and other flow paths flood waters will take to reach an outlet, whether overland or underground.

---

<sup>7</sup> Johnson, William K. (January 1985). *Significance of Location in Computing Flood Damage*. ASCE Journal of Water Resource Planning and Management.

<sup>8</sup> Camp, Dresser and McKee, Inc. (1991). *Buck and Plaster Creek Stormwater Management Masterplan*, prepared for the Kent County Drain Commissioner.



## D. Pretreatment

### Where Required

Pretreatment is required prior to discharging stormwater runoff to the following structural BMPs to preserve the longevity and function of the BMP:

1. Detention and retention basins
2. Infiltration practices
3. Bioretention/rain gardens
4. Constructed filters
5. Stormwater reuse
6. Water quality swales

### Treatment BMPs

Pretreatment provides for the removal of fine sediment, trash, and debris. Methods of pretreatment include:

1. Forebays (including spill containment cells and level spreaders)
2. Vegetated filter strips (including buffers and green roofs)
3. Vegetated swales (including natural flow paths)
4. Water quality devices

### Standard

#### Sediment Forebay

A minimum pretreatment volume equivalent to 15% of the water quality volume is required for sediment forebays using gravity.

*Note:* This is a conservative approximation of results given by the Hazen Equation for sediment basin sizing using a 50% settling efficiency for a 50-micron particle (silt) with a 1-year peak inflow, consistent with recommendations in the *Low Impact Development Manual for Michigan* (SEMCOG 2008).

#### Vegetated Filter Strip

Provide a 10-foot minimum sheet-flow length at a maximum slope of 2% with an impervious approach length no greater than 3.5 times the filter strip length, up to a maximum approach length of 75 feet.

Provide a 15-foot minimum sheet flow length for slopes between 2% and 6% with an impervious approach length no greater than 3 times the filter strip length, up to a maximum approach length of 75 feet.

#### Vegetated Swale

Provide a 20-foot minimum length at a maximum slope of 4% with a 1-foot high check dam at the downstream end, and a maximum upstream drainage area of 0.13 acre per 2-foot of bottom width.

*Note:* Minimum lengths for vegetated filter strips and vegetated swales are selected to provide a workable length for small sites and right-of-way constraints, while providing an area for sediment to drop out of suspension. Vegetated filter strip sizing for pretreatment from *Design of Stormwater Filtering Systems* (Center for Watershed Protection, 1996). Vegetated swale upstream area ratio assumes a 1-year peak inflow (rainfall intensity of 2.16 inches per hour for a time-of-concentration of 15 minutes) from an impervious area, with a settling efficiency of 50% for a 50-micron particle (silt).

#### Water Quality Device

Configured to trap floatables and sediment. Follow manufacturer's guidelines.

## E. Hot Spots

### Where Required

Sites considered to be stormwater hot spots are identified in [Table 2](#). Industrial and commercial land use activities on these sites involve the production, transfer, and/or storage of hazardous materials in quantities that pose a high risk to surface and groundwater quality (those exceeding 55 gallons aggregate for liquids and 440 pounds aggregate for dry weights), as defined in Part 5 Rules: Spillage of Oil and Polluting Materials, under Water Resources Protection (Part 31, Act 451, PA 1994). Sites of soil or groundwater contamination under Part 201 Environmental Remediation and Part 213 Leaking Underground Storage Tanks (Act 451, PA 1994) are also included in [Table 2](#).

### Standard

Pretreatment volume with a minimum of 400 gallons required for spill containment.

*Note:* The minimum volume provides a reasonable capture size (e.g. a standard liquid propane truck has a hauling capacity of 1,000 gallons) that can be accommodated with a 6-foot diameter water quality device.

Pretreatment BMPs must have an impermeable barrier between the treated material and the groundwater and have provisions for the capture of oil, grease, and sediments.

### Treatment BMPs

Infiltration BMPs will be reviewed to meet performance standards in areas of soil or groundwater contamination to ensure a site design that does not exacerbate existing conditions. Specific stormwater management strategies for areas of existing contamination and hotspots include the following:

1. Isolate transfer and storage areas from permeable surfaces and reduce exposure to stormwater.
2. Identify opportunities for use of infiltration BMPs in other areas of the site.
3. Where storage and transfer areas exposed to stormwater cannot be avoided:
  - a. Infiltration of runoff from parking lots and road surfaces is discouraged in favor of a surface water discharge.
  - b. Pervious pavements that infiltrate into the groundwater are not permitted because they do not allow for any pretreatment or spill containment.
  - c. Perforated pipes for infiltration are not permitted due to the difficulty in isolating an accidental spill.

**Table 2 – Stormwater Hot Spots**

2012 North American Industry Classification System (NAICS)	
31 – 33	Manufacturing
44 – 45	Retail Trade (441 Motor Vehicle and Parts Dealers, 444 Building Material and Garden Equipment and Supplies Dealers, 447 Gasoline Stations, 454 Non-store Retailers (e.g. fuel dealers))
48 – 49	Transportation and Warehousing
71	Arts, Entertainment, and Recreation (79393 Marinas)
81	Other Services (8111 Automotive Repair and Maintenance, 8113 Commercial and Industrial Machinery and Equipment Repair and Maintenance, 8123 Dry Cleaning and Laundry Services, 8129 Other Personal Services (e.g. photofinishing laboratory))
	Salvage Yards and Recycling Facilities
	Sites classified under Part 201 Environmental Remediation and Part 213 Leaking Underground Storage Tanks (Act 451, PA 1994) of the Michigan compiled laws
	Areas with the potential for contaminating public water supply intakes
	Other land uses and activities where petroleum products, chemicals or other polluting materials have a high probability of polluting surface or groundwater due to quantity of use, storage or waste products generated, as determined by the City.
Many of these sites will also be regulated under the EPA NPDES Industrial Stormwater Program. A detailed list of NAICS industries can be found at: <a href="http://www.census.gov/cgi-bin/sssd/naics/naicsrch?chart=2012">http://www.census.gov/cgi-bin/sssd/naics/naicsrch?chart=2012</a>	

## F. Coldwater Streams

### Where Required

Coldwater streams require an adequate and stable base flow to maintain their designation and support a cold-water fishery. Designated trout stream maps are available on the Michigan Department of Natural Resources (MDNR) [website](#).

### Treatment BMPs

Development practices that increase surface water temperature or eliminate groundwater recharge should be avoided. The following strategies apply to developments located within a watershed of a designated trout stream that also propose a surface water discharge to the coldwater stream. Strategies must be identified on the site plan and/or submittal package.

1. Protect riparian buffers.
2. Stormwater disconnection.
3. Incorporate heat-reducing BMPs such as green roofs and re-forestation.
4. Implement structural BMPs that control volume through infiltration.
5. If detention ponds are used, detention times must be limited to a maximum of 12 hours.
6. Wet ponds should draw water from near the pond bottom to maintain a cooler discharge water temperature.

## G. Watershed Policy Statements

Specific stormwater policies have been adopted by the City for the watersheds identified in **Appendix 2**.

These policy recommendations have resulted from hydrologic and hydraulic analysis and/or monitoring performed during engineering studies. The policy statements identify specific stormwater management standards and the areas where these standards must be used to meet resource protection goals.

If the site is located within one of the identified watersheds, the stormwater management plan for the site must also comply with the policy statements.

### III. DESIGN PROCESS

The stormwater site design process is summarized in the steps below. This process is intended to minimize negative impacts from development sites that could be avoided through proper planning.

#### A. Identify Sensitive Areas

Identify existing environmentally sensitive areas on the site plan that may require special consideration or pose a challenge for stormwater management. For the purpose of these standards, sensitive areas include:

1. Waterbodies (lakes and ponds)
2. Rivers and streams
3. Floodplains (and flood prone areas)
4. Riparian areas
5. Wetlands
6. Woodlands
7. Sand dunes
8. Natural drainageways
9. Soils and topography (erodible, steep)
10. Susceptible groundwater supplies
11. Threatened and endangered species habitat

Sensitive areas are determined on a site-specific basis through survey, delineation, aerial photographs, or maps. Sensitive areas must be shown on the site map or drawings. The total acreage of protected areas must also be indicated. The Developer must demonstrate a good faith effort to maximize protection of sensitive areas.

#### B. Select Source Controls

Source controls reduce the volume of runoff generated onsite, encourage infiltration and evapotranspiration, and prevent pollutants from entering the drainage system. Non-structural BMPs are used for this purpose. Maximize the use of non-structural BMPs as the most effective option for controlling stormwater to meet sensitive area protection requirements and reduce the size of site runoff controls.

#### C. Size Runoff Controls

After source controls have been maximized, site runoff controls are typically needed to manage the additional post-development stormwater runoff. Determine the standards applicable to the site to properly size runoff controls. Minimum standards are given in [Table 1](#). Identify any additional standards required in Watershed Policy Statements.

#### D. Confirm an Adequate Outlet

Once all onsite source and runoff controls have been implemented, excess runoff can be discharged offsite. The design criteria specified in this manual is generally protective of the receiving waterbody. However, the Developer must always demonstrate an adequate outlet exists downstream of the development to receive the design rate, volume, and concentration of the post-development site runoff. Discharge from the site, including discharge from emergency overflow spillways and pipes, must not cause adverse impact to downstream properties or infrastructure (refer to Part 2 section “Stormwater Discharge”).

## E. Select Best Management Practices (BMPs)

Select appropriate stormwater BMPs to meet minimum required pollutant reduction, volume, and peak rate requirements. A list of common BMPs and their treatment ability is given in **Table 3**. The BMPs selected must be designed in accordance with the calculation methods and design criteria provided in **Appendix 3** of this manual. BMPs proposed for use, but not included in this manual will be evaluated on an individual basis.

**Table 3 – Stormwater BMP Matrix**

Stormwater BMP	Treatment			
	Requires Pretreatment	TSS Removal Efficiency	Provides Pretreatment	Provides Spill Containment
<b>Non-Structural BMPs</b>				
Minimal Disturbance Area				
Protect Natural Flow Pathways			X	
Protect Sensitive Areas				
Native Revegetation			X	
Stormwater Disconnect				
<b>Structural BMPs – Conveyance and Storage</b>				
Storm Sewer		(22)		X
Culvert or Bridge				
Open Channel				
Detention Basin (dry)	X	(49)		
Detention Basin (wet)	X	(80)		
Detention Basin (extended/wetland)	X	(72)		
Retention Basins	X	(89)		
<b>Structural BMPs – LID and Small Site</b>				
Infiltration Practices	X	(89)		
Bioretention/Rain Garden*	X	(86)		
Bioswale*		(86)	X	
Constructed Filter	X	(86)	X	
Planter Box*		(59)		
Pervious Pavement*		(84)		
Pervious Pavement* (roof discharge to stone)		(50)		
Capture Reuse	X	(*)		X
Vegetated Roof		(*)	X	
Water Quality Device		(*)	X	X
Sediment Forebay		(50)	X	
Spill Containment Cell		(50)	X	X
Water Quality Swale		(86)	X	X
Vegetated Swale		(81/50)	X	
Vegetated Filter Strip		(81/50)	X	
Level Spreader			X	
Blank	No. BMP does not provide treatment.			
X	Yes.			
( )	BMP may be used to meet water quality treatment criteria. Median TSS Removal Efficiency in percent.			
	Source: Fraley-McNeal, L. (September 2007). <i>National Pollutant Removal Performance Database, Version 3</i> , Center for Watershed Protection. Bioretention/Rain Garden, Bioswale and Water Quality Swale same as Constructed Filter. Pervious Pavement average TSS Removal. Source: Rowe, Amy A., Borst, Michael, and O'Connor, Thomas P. (2007). <i>Pervious Pavement System Evaluation</i> , EPA, Office of Research and Development.			
	Storm Sewer average TSS removal for standard catch basin. Source: Pitt, R. and Field, R. (1998). <i>An Evaluation of Storm Drainage Inlet Devices for Stormwater Quality Treatment</i> , WEFTEC'98 Water Environment Federation 71st Annual Conference & Exposition, Proceedings Volume 6, Facility Operations I&II.			

**Table 3 – Stormwater BMP Matrix**

Stormwater BMP	Treatment			
	Requires Pretreatment	TSS Removal Efficiency	Provides Pretreatment	Provides Spill Containment
	Sediment Forebay, Spill Containment Cell, and Vegetated Swale/Vegetated Filter Strip sized for pretreatment: 50% settling efficiency used.			
( / )	BMP sized for water quality treatment / BMP sized for pretreatment only.			
(*)	Submit independent third-party testing results of pollutant removal efficiency for review.			
*	TSS removal efficiency assumes underdrained BMP, use value for Infiltration Practices if BMP has no underdrain.			
Notes: Design criteria in this manual is provided to meet or exceed the median TSS removal efficiency.				

## I. SOILS INVESTIGATION

### A. Qualifications

Soils investigation by a qualified geotechnical consultant is required for retention and detention basins, infiltration practices, bioretention/rain gardens, constructed filters, planter boxes, and pervious pavement to determine the site soil infiltration characteristics and groundwater level. The geotechnical consultant shall be a professional engineer, soil scientist, or professional geologist.

### B. Background Evaluation

An initial feasibility investigation shall be conducted to screen proposed BMP sites. The investigation involves review of the following resources:

1. County Soil Survey prepared by the NRCS and USDA Hydrologic Soil Group (HSG) classifications.
2. Existing soil borings, wells, or geotechnical report on the site.
3. Onsite septic percolation testing.
4. Cyclical groundwater levels <http://waterdata.usgs.gov/mi/nwis/gw>

### C. Test Pit/Soil Boring Requirements

A test pit (excavated trench) or soil boring shall be used for geotechnical investigation. Test pits may typically be selected for shallower investigations in locations where groundwater is sufficiently low.

The number of test pits or soil borings will vary depending on site conditions and the proposed development. The minimum number of test pits or soil borings shall be determined from **Table 4**.

Additional tests may be requested based on local conditions and initial findings (e.g. large variability in soil type, high groundwater table).

**Table 4 – Minimum Number of Soil Tests Required**

Type of BMP	Test Pit/Soil Boring	Depth of Test Pit/ Soil Boring	Field Permeability Test
Retention basin Infiltration bed Rain garden Pervious pavement	1 soil boring per 5,000 square feet of bottom area; 2 minimum	10 feet below proposed bottom	1 test per soil boring
Infiltration trench Bioswale	1 soil boring per 100 linear feet of BMP; 2 minimum	10 feet below proposed bottom	1 test per soil boring
Dry well Leaching basin Planter box	1 soil boring minimum	5 feet below proposed bottom	1 test per soil boring
Detention basin	1 soil boring per 10,000 square feet of bottom area; 1 minimum	5 feet below proposed bottom	Not Applicable

Excavate a test pit or soil boring in the location of the proposed BMP. The following conditions shall be noted and described, referenced from a top-of-ground elevation:

1. Depth to groundwater recorded during initial digging or drilling, and again upon completion of the excavation.
2. Depth to bedrock or hardpan.
3. Depth and thickness of each soil horizon including the presence of mottling.
4. USDA soil texture classification for all soil horizons.

Test pit reports and soil boring logs shall include the date(s) data was collected and the location referenced to a site plan.

## D. Highest Known Groundwater Elevation

The highest known groundwater elevation shall be determined by adjusting the measured groundwater elevation using indicators such as soil mottling and regional water level data. It should also take into consideration local conditions that may be temporarily altering water levels at the time of measurement. Such conditions could include, but not be limited to: dewatering, irrigation well or large quantity withdrawals in the area, or areas of groundwater infiltration (such as a nearby retention basin).

## E. Field Permeability Testing

Field permeability testing is required. Laboratory tests are not allowed. Field permeability testing must be conducted before the alternative approach for channel protection will be considered. Acceptable field tests include:

1. Infiltration Rate of Soils in Field Using Double-Ring Infiltrometers (ASTM D3385).
2. Percolation tests (similar to wastewater systems).

The minimum number of field permeability tests shall be determined from **Table 4**. The City reserves the right to request additional field permeability testing be performed on questionable sites.

Tests shall be conducted in the location of the proposed BMP at the proposed bottom elevation. An alternate testing depth may be allowed if material is identical and groundwater is not an issue.

Tests shall not be conducted in the rain or within 24 hours of significant rainfall events (>0.5 inch) or when the ground is frozen.

Field permeability testing reports shall include the date(s) data was collected and the location referenced to a site plan.

### Methodology for Double-ring Infiltrometer Field Test

A double-ring infiltrometer consists of two concentric metal rings. These rings are driven into the ground and filled with water. The outer ring prevents divergent flow. The drop in water level or volume within the inner ring is used to calculate an infiltration rate. The diameter of the inner ring should be approximately 50-70% of the diameter of the outer ring, with a minimum inner ring size of 4 inches.

Equipment for double-ring infiltrometer test:

1. Two concentric rings six inches high or greater.
2. Water Supply.
3. Stopwatch or Timer.
4. Ruler or measuring tape.
5. Flat board for driving the cylinders uniformly into the soil.



6. Log sheets for recording data.

Procedure for double-ring infiltrometer test:

1. Prepare a level testing area.
2. Place the outer ring and use a flat board to drive the ring into the soil a minimum of 2 inches.
3. Place the inner ring in the center of the outer ring and use a flat board to drive the ring into the soil a minimum of 2 inches. The bottom of both rings should be at the same elevation.
4. The test area should be presoaked immediately prior to testing. Fill both rings with water to the rim at 30 minute intervals for 1 hour. The maximum water depth in the rings should be 4 inches. The drop in water level during the last 30 minutes of the presoaking period should be applied to the following standard to determine the interval between readings:
  - a. If the water level drop is 2 inches or more, use 10-minute intervals.
  - b. If the water level drop is less than 2 inches, use 30-minute intervals.
5. Obtain a measurement of the drop in water level in the center ring at appropriate intervals. After each reading, refill both rings to the rim. Measure the water level in the center ring from a fixed reference point and continue at the interval determined until a minimum of 8 readings are made or until a stabilized rate of drop is obtained. A stabilized rate of drop is a difference of  $\frac{1}{4}$  inch or less between the highest and lowest readings of four consecutive readings.
6. The water level drop that occurs in the center ring during the final period of the average stabilized rate represents the infiltration rate for the test location.

### Methodology for Percolation Test

Equipment for percolation test:

1. Post hole digger or auger.
2. Water supply.
3. Stopwatch or timer.
4. Ruler or measuring tape.
5. Log sheets for recording data.
6. Tool for soil scarification.
7. Coarse sand or fine gravel.
8. A fixed reference point during measurement.

Procedure for percolation test:

The percolation test methods are based on the criteria for onsite sewage investigation of soils. A 24-hour presoak is generally not required since infiltration systems will not be continuously saturated.

1. Prepare a level testing area.
2. Prepare a hole with a uniform diameter of 6 to 10 inches and a depth of 8 to 12 inches. Scarify the bottom and sides of the hole to remove any smeared soil surfaces and to provide a natural soil interface for percolation. Remove loose material from the hole.
3. Place 2 inches of coarse sand or gravel in the bottom of the hole to protect the soil from scouring or clogging.

4. Presoak the hole immediately prior to testing. Place water in the hole to a minimum depth of 6 inches over the bottom and readjust every 30 minutes for 1 hour.
5. Apply the following standard to the drop in water level during the last 30 minutes of the final presoaking period.
  - a. If water remains in the hole, the interval for readings during the percolation test is 30 minutes.
  - b. If no water remains in the hole, the interval for readings during the percolation test is reduced to 10 minutes.
6. After the final presoaking period, adjust the water in the hole to a minimum depth of 6 inches and readjust when necessary. Record the water level depth and hole diameter.
7. Make water level measurements from a fixed reference point and continue measurements at the predetermined interval until a minimum of 8 readings are completed or until a stabilized rate of drop in water level is obtained. A stabilized rate of drop is a difference of ¼ inch or less between the highest and lowest readings of 4 consecutive readings.
8. The water level drop that occurs in the center ring during the final period of the average stabilized rate represents the infiltration rate for the test location.
9. The average measured rate must be adjusted to account for the discharge of water from both the sides and bottom of the hole and to develop a representative infiltration rate. Adjust the final percolation rate according to the following formula:

$$\text{Infiltration Rate} = (\text{Percolation Rate}) / (\text{Reduction Factor})$$

Where the reduction factor is given by:

$$Rf = \frac{2d1 - \Delta d}{DIA}$$

$d1$  = Initial Water Depth in.

$$\Delta d = \frac{\text{Average}}{\text{Final}} \text{Water Level Drop (in.)}$$

$DIA$  = Diameter of Percolation Hole (in.)

The percolation rate is simply divided by the reduction factor as calculated above to yield the representative infiltration rate. In most cases, the reduction factor varies from 2 to 4 depending on the percolation hole dimensions and water level drop. (Wider shallower tests have lower reduction factors because proportionately less water exfiltrates through the sides.)

*Note:* The area reduction factor accounts for the exfiltration occurring through the sides of the percolation hole. It assumes the rate is affected by the depth of water in the hole and that the percolating surface of the hole is uniform soil. If these assumptions are not true, then other adjustments may be necessary.

## F. Design Infiltration Rates

A conservative value for the infiltration rate is used to calculate the storage volume of infiltration BMPs due to the uncertainty the soil will infiltrate at the design rate during the time the basin is filling.

The infiltration rate determined from field permeability testing shall be divided by a factor of 2 to calculate the design infiltration rate, up to a maximum design infiltration rate by soil texture class provided in **Table 5**. The

design infiltration rate shall be used to calculate the storage volume and minimum infiltration area of the BMP necessary to drain in the allotted drawdown time.

The least permeable soil horizon within 4 feet below the proposed BMP bottom elevation shall be used to select the design infiltration rate.

Soil testing, following the requirements as outlined in Part 4, Section E of this document will be conducted to assess the soils before the alternative approach can be considered.

**Table 5** provides design values of the infiltration rate and effective water capacity (void ratio) for soils based on their textural classification. The soil textural classes shown in **Table 5** correspond to the soil textures of the USDA Soil Textural Triangle shown in **Figure 1**.

*Note:* Infiltration is the process by which water on the ground surface enters the soil. Infiltration rate is a measure of the rate at which soil is able to absorb rainfall or irrigation in inches per hour. The rate decreases as the soil becomes saturated. The design infiltration rate assumes saturated conditions and closely approximates the hydraulic conductivity (typically given in feet per day) of the near-surface soil.

*Note:* The effective water capacity of a soil is the fraction of the void spaces available for water storage measured in inches per inch.

**Table 5 – Design Infiltration Rates by USDA Soil Texture Class**

Soil Texture Class	Effective Water Capacity <sup>1</sup> (inches per inch)	Design Infiltration Rate <sup>2</sup> (inches per hour)	HSG
Gravel	0.40	3.60	A
Sand	0.35	3.60	A
Loamy Sand	0.31	1.63	A
Sandy Loam	0.25	0.50	A
(Medium) Loam	0.19	0.24	B
Silty Loam / (Silt)	0.17	0.13	B
Sandy Clay Loam	0.14	0.11	C
Clay Loam	0.14	0.03	D
Silty Clay Loam	0.11	0.04	D
Sandy Clay	0.09	0.04	D
Silty Clay	0.09	0.07	D
Clay	0.08	0.07	D

<sup>1</sup>Source: Maryland Department of Environment (2000). *Maryland Stormwater Design Manual*, Appendix D.13, Table D.13.1 (Rawls, Brakensiek and Saxton, 1982).

<sup>2</sup>Source: Wisconsin Department of Natural Resources (2004). *Site Evaluation for Stormwater Infiltration (1002)*, Table 2 (Rawls, 1998). *Note:* Values are reduced by approximately a factor of 2 from those given in Table D.13.1.

## G. Minimum Allowable Infiltration Rate

Soil textures with design infiltration rates less than 0.24 inches per hour are deemed not suitable for infiltration BMPs.

Soils with design infiltration rates as low as 0.24 inches per hour may be used for LID and Small Site BMPs if suitable supplemental measures are included in the design. Supplemental measures may include subsoil amendment, or underdrain placed at the top of the storage bed layer.

Figure 1 – USDA Soil Textural Triangle

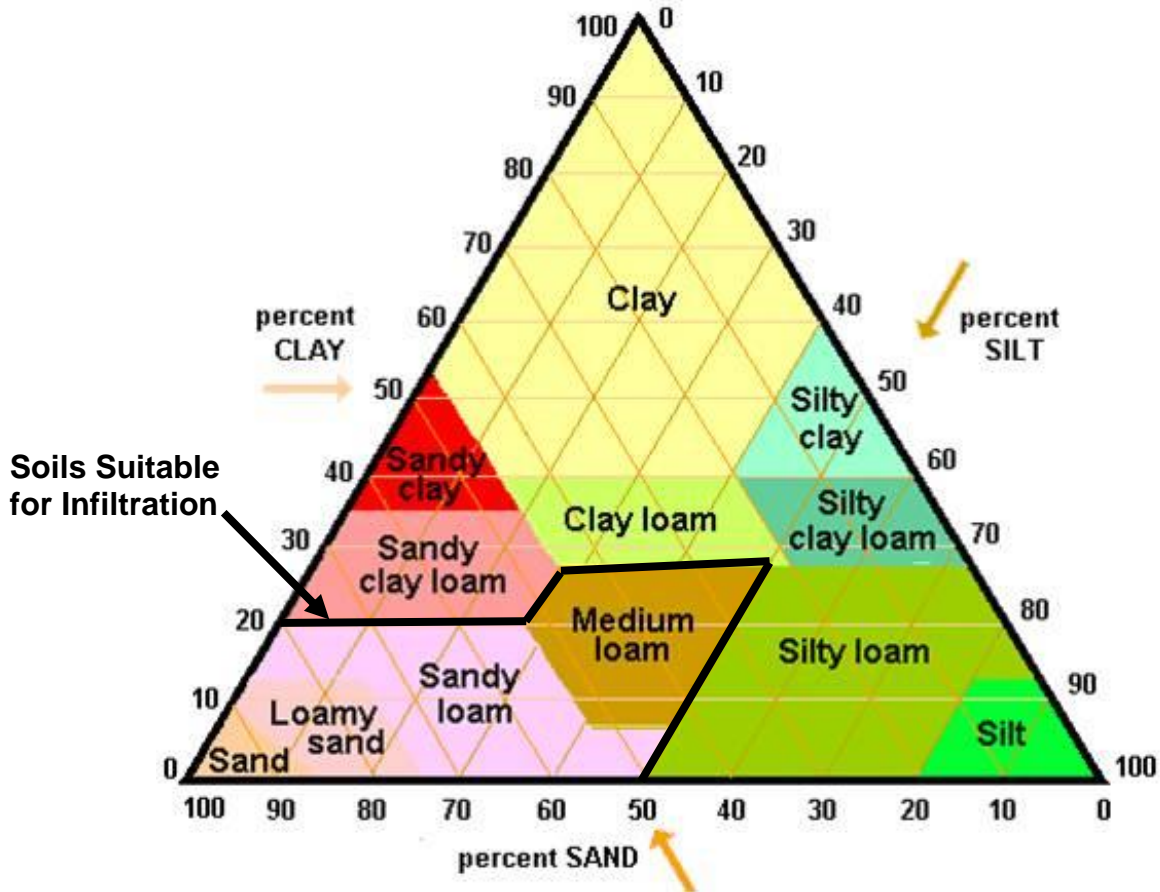

## II. CALCULATION METHODOLOGY

The Rational Method and the NRCS Runoff Curve Number Method are typically used to calculate stormwater runoff, peak discharges and runoff volumes for design of stormwater conveyance and storage systems. The NRCS method is presently the only acceptable method to calculate the channel protection volume. The Small Storm Hydrology Method is used to calculate runoff volumes from the smaller rainfall amounts used for water quality treatment.

### A. Calculating Runoff

#### 1. Rational Method

The Rational Method may be used to calculate stormwater runoff volumes and peak discharges to size conveyance and storage systems for contributing drainage areas of 40 acres or less. The peak runoff rate is given by the equation:

$$Q = CIA \quad (4.1)$$

where:

- $Q$  = peak runoff rate (cubic feet per second).
- $C$  = weighted runoff coefficient of the drainage area.
- $I$  = average rainfall intensity for a storm with a duration equal to the time of-concentration of the drainage area (inches per hour). Use rainfall amounts from **Table 10** and divide by the duration in hours to obtain the average rainfall intensity ( $I$ ).
- $A$  = drainage area (acres).

Runoff coefficients sizing conveyance systems shall be selected from **Table 6**.

**Table 6 – Rational Method Runoff Coefficients  
(2 to 500-year rainfall frequencies)**

Character of Surface	Return Period (years)						
	2	5	10	25	50	100	500
Asphaltic	0.75	0.85	0.95	0.97	1.00	1.00	1.00
Concrete/roof	0.75	0.85	0.95	0.97	1.00	1.00	1.00
Grass areas (lawns, parks, etc.)							
<i>Poor condition</i> (grass cover less than 50% of the area)							
Flat, 0 to 2%	0.32	0.34	0.37	0.40	0.44	0.47	0.58
Average, 2% to 7%	0.37	0.40	0.43	0.46	0.49	0.53	0.61
Steep, over 7%	0.40	0.43	0.45	0.49	0.52	0.55	0.62
<i>Fair condition</i> (grass cover 50% to 75% of the area)							
Flat, 0 to 2%	0.25	0.28	0.30	0.34	0.37	0.41	0.53
Average, 2% to 7%	0.33	0.36	0.38	0.42	0.45	0.49	0.58
Steep, over 7%	0.37	0.40	0.42	0.46	0.49	0.53	0.60
<i>Good condition</i> (grass cover larger than 75% of the area)							
Flat, 0 to 2%	0.21	0.23	0.25	0.29	0.32	0.36	0.49
Average, 2% to 7%	0.29	0.32	0.35	0.39	0.42	0.46	0.56
Steep, over 7%	0.34	0.37	0.40	0.44	0.47	0.51	0.58
Source: C.T. Haan, B.J. Barfield, J.C. Hayes (1994). <i>Design Hydrology &amp; Sedimentology for Small Catchments</i> .							

Runoff coefficient for sizing detention/retention basins, which are designed for higher rainfall frequencies, shall be selected from **Table 6**.

Time-of-concentration for the Rational Method is the sum of overland flow and channel flow. A minimum of 15 minutes shall be used.

Overland flow time may be calculated using the following formula:

$$t_o = \left( \frac{2Ln}{3\sqrt{s}} \right)^{0.4673} \quad (4.2)$$

where:

- $t_o$  = time of overland flow (minutes)
- $L$  = length (feet); the distance from the extremity of the subcatchment area in a direction parallel to the slope until a defined channel is reached. Overland flow will become channel flow within 1,200 feet in almost all cases\*
- $n$  = surface retardants coefficient (from **Table 7**)

- $s$  = slope (feet per foot); the difference in elevation between the extremity of the subcatchment area and the point in question divided by the horizontal distance

**Table 7 – Surface Retardants Coefficients**

Type of Surface	Coefficient (n value)
Smooth impervious surface	0.02
Smooth bare packed soil	0.10
Poor grass, cultivated row crops, or moderately rough bare surface	0.20
Pasture or average grass	0.40
Deciduous timberland	0.60
Conifer timberland, deciduous timberland with deep forest litter, or dense grass	0.80

\*Source: Formula, coefficients and empirical observations from W.S. Kerby, J.M. Asce. Servis, Van Doren & Hazard Engineers, Topeka, Kansas. "Time of Concentration for Overland Flow" as included in ENGINEER'S NOTEBOOK.

Channel flow shall be calculated using Manning's equation:

$$V = \frac{An}{1.49R^{\frac{2}{3}}S^{\frac{1}{2}}} \quad (4.3)$$

where:

- $V$  = velocity (feet per second)  
 $A$  = wetted area (square feet)  
 $n$  = Manning's roughness coefficient (from **Table 12**)  
 $R$  = hydraulic radius (feet)  
 $S$  = slope (feet per foot)

The time-of-concentration is then:

$$Tc = t_o + \frac{L_c}{60V} \quad (4.4)$$

where:

- $Tc$  = time-of-concentration (minutes)  
 $t_o$  = time of overland flow (minutes)  
 $L_c$  = length of channelized flow (feet)  
 $V$  = velocity of channelized flow (feet per second)  
 $60$  = factor to convert seconds to minutes

## 2. Runoff Curve Number Method

The Runoff Curve Number Method developed by the NRCS may be used to calculate stormwater runoff volumes and peak discharges to size conveyance and storage systems. This method must be used when it is necessary to calculate runoff volumes for channel protection. The formulas are as follows:

$$Q_v = \frac{(P - 0.2S)^2}{(P + 0.8S)} \quad (4.5)$$

where:

$Q_v$  = surface runoff (inches). *Note:*  $Q_v=0$  if  $P \leq 0.2S$

$P$  = rainfall (inches)

$S$  = potential maximum retention after runoff begins (inches)

and where:

$$S = \frac{1000}{CN} - 10 \quad (4.6)$$

Surface runoff ( $Q_v$ ) is calculated separately for each land use and soil type combination. Total runoff volume can then be calculated by the formula:

$$V_t = (\sum_i Q_{vi} A_i) \times 3630 \quad (4.7)$$

where:

$V_t$  = total runoff volume of the design storm (cubic feet)

$Q_v$  = surface runoff for the  $i^{\text{th}}$  land use (inches)

$A$  = contributing area associated with the  $i^{\text{th}}$  land use (acres)

3630 = factor to convert acre-inches to cubic feet

Curve Number (CN) values are taken from Technical Release No. 55 (TR-55), and provided in **Table 8**.

The “Water” cover type shall be used for detention/retention basins with a permanent pool or surface water temporarily ponded during the rain event. The “Meadow” or “Open spaces” cover type may be used for vegetative BMPs, including those that temporarily pond surface water, to receive credit for channel protection.

### Peak Discharge

The LGROW Design Spreadsheet, or NRCS computer software such as WinTR-55 may be used to calculate peak stormwater runoff rates. A Michigan Unit Hydrograph is used in the LGROW Design Spreadsheet and can be input into WinTR-55.

*Note:* Using the standard NRCS unit hydrograph will overestimate peak runoff rates by 30 to 50 percent or more.



**Table 8 – Curve Numbers (CNs) from TR-55**

Land Use Description		Curve Number <sup>1</sup>			
Cover Type	Hydrologic Condition <sup>2</sup>	Hydrologic Soil Group			
		A	B	C	D
Cultivated land	Poor	72	81	88	91
	Good	64	75	82	85
Pasture or range land	Poor	68	79	86	89
	Fair	49	69	79	84
	Good	39	61	74	80
Meadow		30	58	71	78
Orchard or tree farm <sup>3</sup>	Poor	57	73	82	86
	Fair	43	65	76	82
	Good	32	58	72	79
Woods	Poor	45	66	77	83
	Fair	36	60	73	79
	Good	30 <sup>4</sup>	55	70	77
Open spaces (grass cover) <sup>5</sup>	Poor	68	79	86	89
	Fair	49	69	79	84
	Good	39	61	74	80
Paved parking lots, roofs, driveways		98	98	98	98
Gravel <sup>6</sup>		88	93	94	95
Bare Soil		77	86	91	94
Water <sup>7</sup>		100	100	100	100

Source: U.S. Department of Agriculture Soil Conservation Service (1986). *Urban Hydrology for Small Watersheds, Technical Release No. 55.*

<sup>1</sup>Antecedent moisture condition II and initial abstract ( $I_a$ ) = 0.2S

<sup>2</sup>Poor Condition: pasture or open space with less than 50% ground cover or heavily grazed with no mulch; woods, forest litter, small trees, and brush that are destroyed by heavy grazing or regular burning.

Fair Condition: pasture or open space with 50% to 75% grass cover and not heavily grazed; woods are grazed but not burned, and some forest litter covers the soil.

Good Condition: cultivated land (row crops, straight row) with conservation treatment (crop residue cover), also small grain; pasture or open space with 75% or more ground cover and lightly or only occasionally grazed; woods are protected from grazing, and litter and brush adequately cover the soil.

<sup>3</sup>CN's shown were computed for areas with 50% woods and 50% grass (pasture) cover. Other combinations of conditions may be computed from the CN's for woods and pasture.

<sup>4</sup>Actual curve number is less than 30; use CN = 30 for runoff computations.

<sup>5</sup>CN's shown are equivalent to those of pasture.

<sup>6</sup>Surface only; not including right-of-way.

<sup>7</sup>Water added.

Time-of-concentration for the Runoff Curve Number Method shall be calculated using NRCS TR-55 methodology as outlined below. A minimum of 0.1 hour (6 minutes) shall be used.

The flow path is split into three sections – sheet flow, shallow concentrated flow, and open channel flow. The travel time is computed for each flow regime. The time-of-concentration is then the sum of the travel times:

$$Tc = t_1 + t_2 + t_3 \quad (4.8)$$

(1) For sheet flow the travel time ( $t_1$ ) in hours is given as:

$$t_1 = \frac{0.007(nL)^{0.8}}{P_2^{0.5}s^{0.4}} \quad (4.9)$$

where:

$n$  = Manning's roughness coefficient from **Table 12**

$L$  = flow length (feet)

$P_2$  = 2-year, 24-hour precipitation depth from **Table 10**

$s$  = slope (feet/foot)

(2) Shallow concentrated flow velocities are calculated for paved and unpaved surfaces. The velocities are given as:

$$v = \begin{matrix} 16.1345s^{0.5} & \text{Unpaved} \\ 20.3282s^{0.5} & \text{Paved} \end{matrix} \quad (4.10)$$

where:

$s$  = slope (feet/foot)

$v$  = velocity in feet per second

The flow length (feet) is then divided by the velocity (feet per second) and a conversion factor of 3600 to obtain travel time ( $t_2$ ) in hours:

$$t_2 = \frac{L}{3600v} \quad (4.11)$$

(3) Open channel flow uses Manning's equation to calculate the velocity based on slope, flow area, and wetted perimeter (refer to Equation 4.3). The flow length (feet) is then divided by the velocity (feet per second) to obtain travel time ( $t_3$ ) in hours (refer to Equation 4.11).

#### BMP Residence Time

BMP residence time shall be calculated as the storage volume divided by the 10-year peak inflow rate.

### 3. Small Storm Hydrology Method

The Small Storm Hydrology Method is used to calculate the water quality treatment volume. The method was developed to estimate the runoff volume from urban land uses for relatively small storm events where the Rational and NRCS Methods prove less accurate. Water quality volume is calculated by the formula:

$$V_{wq} = ARv(1)(3630) \quad (4.12)$$

where:

- $V_{wq}$  = minimum required water quality volume (cubic feet)
- $A$  = area (acres); the developed portion of the site, both impervious and pervious, not receiving treatment with a non-structural BMP
- $Rv$  = area-weighted volumetric runoff coefficient (from **Table 9**)
- $1$  = 90% non-exceedance storm rainfall amount (inches)
- $3630$  = factor to convert acre-inches to cubic feet

The Volumetric Runoff Coefficients ( $Rv$ ) provided in **Table 9** are similar to the Rational runoff coefficient, but are exclusive to the rainfall amount (1-inch).

**Table 9 – Runoff Coefficients for Small Storm Hydrology Method**

Rainfall Amount (inches)	Volumetric Runoff Coefficient, $Rv$					
	Directly Connected Impervious Area			Disturbed Pervious Area		
	Flat Roofs/ Unpaved	Pitched Roofs	Paved	Sandy Soils (HSG A)	Silty Soils (HSG B)	Clayey Soils (HSG C&D)
1.0	0.815	0.965	0.980	0.035	0.120	0.2015

Source: Adapted from SEMCOG (2008). *Low Impact Development Manual for Michigan*, Table 9.3. (R. Pitt (2003). *The Source Loading and Management Model (WinSLAMM): Introduction and Basic Uses*).

The area-weighted volumetric runoff coefficient, RV, is calculated as:

$$Rv = \frac{A_1Rv_1 + A_2Rv_2 + \dots + A_nRv_n}{A}$$

where:

- $Rv_n$  = runoff coefficient for sub-area n
- $A_n$  = area of sub-area n (acres)
- $A$  = Sum of the areas of all sub-areas (acres)

## B. Rainfall

The rainfall duration-frequency table provided in **Table 10** shall be used with the Rational Method to determine rainfall intensity for rainfall duration equal to the time-of-concentration. Divide the rainfall amount by the duration in hours to obtain the rainfall intensity.

The 24-hour rainfall amounts provided in **Table 10** shall be used with the Runoff Curve Number Method.

An MSE4 rainfall distribution shall be used when a unit hydrograph approach is used (e.g. WinTR-55 computer program).

**Table 10 – Rainfall Amounts (inches)**

Duration	1-Year	2-Year	5-Year	10-Year	25-Year	50-Year	100-Year
24-hr	2.22	2.56	3.18	3.77	4.66	5.43	6.27
12-hr	1.95	2.25	2.81	3.33	4.13	4.82	5.56
6-hr	1.69	1.96	2.45	2.91	3.60	4.19	4.82
3-hr	1.45	1.69	2.11	2.50	3.08	3.57	4.09
2-hr	1.31	1.53	1.92	2.26	2.78	3.21	3.66
1-hr	1.05	1.24	1.55	1.83	2.24	2.58	2.94
30-min	0.80	0.94	1.18	1.39	1.70	1.95	2.21
15-min	0.54	0.63	0.79	0.93	1.14	1.31	1.49
10-min	0.44	0.52	0.65	0.76	0.93	1.07	1.22
5-min	0.30	0.35	0.44	0.52	0.64	0.73	0.83

Source: NOAA (2013). *Atlas 14, Precipitation-Frequency Atlas of the United States, Volume 8, Version 2.0.*

Rainfall amounts from: GRAND RAPIDS INTL AP. Station ID 20-3333.

## C. Calculating Storage Volumes and Release Rates

### 1. Water Quality

Treatment of the runoff generated from 1 inch of rain (the 90% annual nonexceedance storm) over the developed portion of the site is required. Water quality volume is calculated using the Small Storm Hydrology Method.

Calculation of the TSS removal efficiency for BMPs in a series is described in Part 4 section “TSS Accounting.”

### 2. Pretreatment

Pretreatment volume may be included in the total water quality volume, and is calculated as:

$$V_{pt} = 0.15(V_{wq}) \quad (4.13)$$

where:

$V_{pt}$  = minimum required pretreatment volume (cubic feet)

$V_{wq}$  = water quality volume (cubic feet)

### 3. Channel Protection

#### a. Retention

Channel protection consists of retaining onsite the net increase in runoff volume between pre-development and post-development conditions for a 2-year, 24-hour storm using the Runoff Curve Number Method. Channel protection volume is calculated with the following equation:

$$V_{cp} = V_{t_{post}} - V_{t_{pre}} \quad (4.14)$$

where:

$V_{cp}$  = minimum required channel protection volume (cubic feet)

$V_{t_{post}}$  = total runoff volume of the 2-year, 24-hour storm for post-development conditions

$V_{t_{pre}}$  = total runoff volume of the 2-year, 24-hour storm for pre-development conditions

Pre-development is defined as the last land use prior to the planned new development or redevelopment.

b. Extended Detention

If retention of the total channel protection volume is not possible due to site constraints, an alternative approach using extended detention may be allowed.

The storage volume of an extended detention basin shall be sized for that part of the 2-year volume difference not met by retention, with a maximum release rate that results in a 24-hour detention time. The peak discharge for a 24-hour detention time may be calculated assuming triangular inflow and outflow hydrographs with a lag between the peaks of 24 hours. If the inflow peak occurs 12 hours into the 24-hour inflow hydrograph, the outflow peak should occur 36 hours into a 72-hour outflow hydrograph as shown in **Figure 2**. The extended detention peak discharge can then be computed with the following equation:

$$Q_{ED} = (V_{cp} - V_{ret}) / (36 * 3600) \quad (4.15)$$

where:

- $Q_{ED}$  = peak extended detention release rate (cubic feet per second)
- $V_{cp}$  = total channel protection volume required (cubic feet)
- $V_{ret}$  = channel protection volume met by retention (cubic feet)
- $36 * 3600$  = half of the base time of outflow hydrograph (seconds)

The 2-year peak discharge after extended detention ( $Q_{ED}$ ) must be equal to or less than the existing 1-year peak discharge. (Exceptions may be made for HSG A, where extended detention has been approved due to site constraints, but existing runoff is zero.) If the 1-year peak discharge limit is not met, the total channel protection volume provided must be increased to reduce the required extended detention volume. Simply using a lower extended detention release rate will violate the 72 hour drawdown time requirement.

**Figure 2 – Extended Detention Hydrograph**

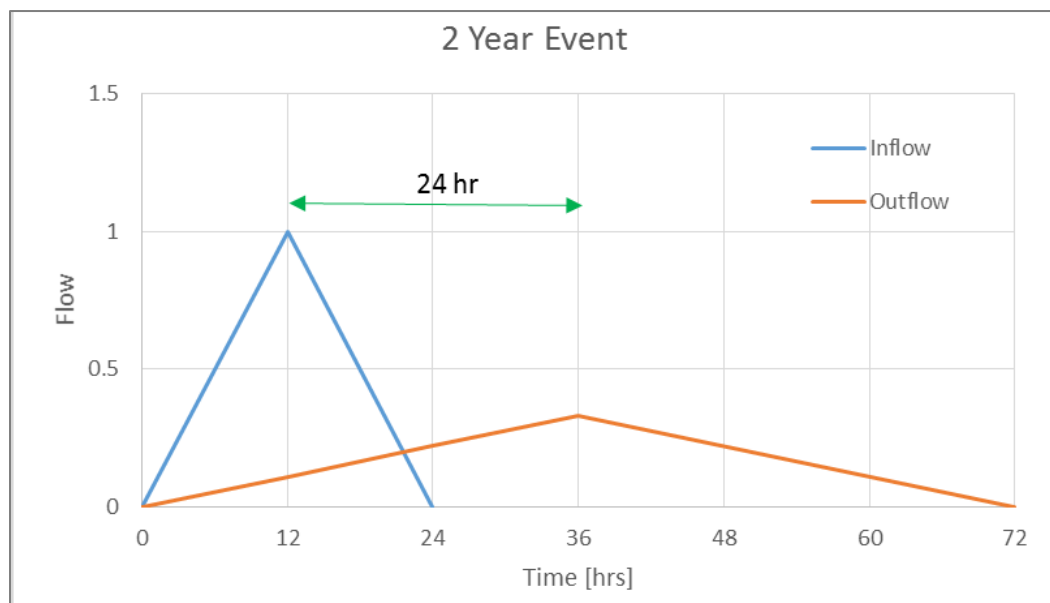

#### 4. Flood Control

Detention and retention basin storage volumes for flood control can be calculated 1) using the methods and equations provided in this section; 2) using the LGROW Design Spreadsheet, which uses the NRCS Curve Number Method and performs pond routing for detention; or 3) using other acceptable hydrologic and hydraulic computer models with submittal of clear and complete input and output

##### a. Detention

Detention of the 100-year rainfall event with a maximum allowable release rate of 0.13 cfs per acre is required, unless an exception is allowed.

##### (1) Rational Method for Detention

If the Rational Method is used, the minimum required storage volume shall be calculated by the “Modified Chicago” Method. Runoff Coefficients for use in detention storage calculations shall be selected from **Table 6** to account for rainfalls exceeding a 10-year frequency. Frequency adjustment of factors of 1.1 and 1.25 have been applied for the 25- and 100-year frequencies respectively, with a maximum value of 1.00.

The calculated storage volume shall be multiplied by 1.25 to obtain the minimum required storage volume.

*Note:* This additional adjustment is necessary since the Modified Chicago Method tends to underestimate the storage volume when compared to pond routing, particularly for short times-of-concentrations (15 to 30 minutes)<sup>9</sup>.

The volume of stormwater runoff stored and infiltrated by upstream retentive BMPs (V<sub>bmp</sub>) may be subtracted from the required detention storage volume.

---

<sup>9</sup> Stahre, Peter and Urbonas, Ben (1990). Stormwater Detention For Drainage, Water Quality and CSO Management, pp. 268 274.

**(2) Runoff Curve Number Method for Detention**

If the Runoff Curve Number Method is used, the minimum required storage volume shall be determined through routing, or may be calculated by the formula:

$$V_{fc} = \frac{(Q_p - Q_{out})}{Q_p} V_t - V_{bmp} \quad (4.16)$$

where:

- $V_{fc}$  = minimum required storage volume for flood control (cubic feet)
- $Q_p$  = peak runoff rate (cubic feet per second)
- $Q_{out}$  = maximum allowable peak discharge (cubic feet per second)
- $V_t$  = post-development runoff volume for the 100-year, 24-hour storm (cubic feet)
- $V_{bmp}$  = total volume (storage + infiltration) provided by upstream retentive BMPs

*Note:* This formula provides a conservative approximation of the required storage volume. Therefore, the volume of any upstream BMPs can be subtracted from the storage volume versus the total runoff volume.

**b. Retention**

Retention basins shall be sized for the 100-year, 24-hour rainfall event.

**(1) Rational Method for Retention**

If the Rational Method is used, the minimum required storage volume shall be calculated by the “Modified Chicago” Method.

The calculated storage volume shall be multiplied by 1.25 to obtain the minimum required storage volume.

The discharge or exfiltration rate into the soil from the retention basin shall be calculated as:

$$Q_{out} = Ai / (12 \times 3600) \quad (4.17)$$

where:

- $Q_{out}$  = discharge rate (cubic feet per second)
- $A$  = infiltration area (square feet)
- $i$  = design infiltration rate (inches per hour)
- $12$  = factor to convert inches to feet
- $3600$  = factor to convert hours to seconds

**(2) Runoff Curve Number Method for Retention**

If the Runoff Curve Number Method is used, the minimum required storage volume ( $V_s$ ) shall be calculated by subtracting the volume infiltrated by the BMP during the infiltration time ( $V_{inf}$ ) from the flood control event runoff volume ( $V_t$ ).

$$V_s = V_t - V_{inf} \quad (4.18)$$



The flood control event runoff volume ( $V_t$ ) is calculated using Equation 4.7.

The infiltrating volume is calculated as:

$$V_{inf} = i * A * t_{inf} / 12 \quad (4.19)$$

where:

$V_{inf}$  = infiltrating volume (cubic feet)

$i$  = design infiltration rate (inches per hour)

$A$  = infiltration area (square feet)

$t_{inf}$  = infiltration time (hours); the period when the BMP is receiving runoff and capable of infiltrating at the design rate

12 = factor to convert inches to feet

Based on extensive computer modelling, the infiltration time is found to be a function of the drain time through the BMP. An empirical formula was developed to model this function for drain times between 0 and 72 hours. Note: this equation is not valid for drain times greater than 72 hours.

$$t_{inf} = 2.0 + t_d \left( 0.222 - 0.553 * \log_{10} \left( t_d / 72 \right) \right) \quad (4.20)$$

The drain time through the BMP is calculated as:

$$t_d = 12 * V_s / (A * i) \quad (4.21)$$

where:

$t_d$  = BMP drain time (hours)

$V_s$  = storage volume of the BMP (cubic feet)

$i$  = design infiltration rate (inches per hour)

$A$  = infiltration area (square feet)

12 = factor to convert inches to feet

The volume of stormwater runoff stored and infiltrated by upstream retentive BMPs ( $V_{bmp}$ ) may be subtracted from the flood control event runoff volume reaching the retention basin.

#### Retentive BMPs Sized for Water Quality and Channel Protection

This method shall be used to calculate the required storage volume of retentive BMPs used for water quality or channel protection by substituting the water quality or channel protection volume for  $V_t$ .

## D. LGROW Design Spreadsheet

The LGROW Design Spreadsheet is a Microsoft Excel spreadsheet application developed for Design and Review Engineers to show compliance with the stormwater standards. The spreadsheet allows the user to size BMPs in series and in parallel, but is not intended to be used for the complete design of BMPs. A copy of the spreadsheet and tutorial is available from the City of Grandville.

### Runoff

The spreadsheet uses the Runoff Curve Number Method to compute runoff volumes by subcatchment. A tabular TR-55 approach is used with a Michigan unit hydrograph to compute peak runoff rates. The spreadsheet can be used to calculate the required channel protection volume and the flood control volume for both detention and retention. The Small Storm Hydrology Method is used to calculate the required water quality volume.

The 24-hour rainfall amounts and rainfall distribution specified in Part 4 section “Rainfall” are incorporated into the spreadsheet. Time-of-concentration formulas from NRCS TR-55 are also incorporated into the spreadsheet to calculate peak discharges. Output is graphed as hydrographs and summarized in tabular form for a range of rainfall frequencies.

The spreadsheet allows the user to select non-structural and structural BMPs to meet required runoff rates and volumes.

### TSS Accounting

The spreadsheet can be used to calculate the TSS reduction for a series of BMPs. The TSS removal efficiencies for the BMPs provided in [Table 3](#) are used to demonstrate a TSS reduction of 80% or more. When BMPs are used in series (i.e. a treatment train) to achieve the 80% reduction, the TSS removal efficiency of the treatment train is calculated as:

$$e_{TSS} = 1 - (1 - e_1)(1 - e_2) \cdots (1 - e_n) \quad (4.22)$$

where  $e_{TSS}$  is the removal efficiency of the treatment train, and  $e_n$  is the removal efficiency for the  $n^{th}$  BMP in the chain of  $n$  BMPs. This calculation assumes all water entering the treatment train is passed through to the next downstream BMP. The spreadsheet allows the user to calculate TSS reduction when either all or a portion of the water quality volume is passed downstream.

BMPs used for water quality treatment can be classified as retentive or pass-through. Retentive BMPs (e.g. infiltration practice) retain and treat some or all of the water quality volume. Pass-through BMPs (e.g. catchbasin) treat all of the water entering and send this volume to the next BMP or subcatchment.

TSS accounting is done by tracking TSS through the subcatchments. In order to do this, it is assumed that one unit of TSS is the mass of TSS carried by one cubic foot of the water quality volume. The effective removal efficiency is the BMP removal efficiency multiplied by the portion of the water quality volume treated by the BMP. The TSS removed for each BMP is the effective removal efficiency multiplied by the TSS remaining in the treatment train.

The TSS removal efficiency for the subcatchment and/or site is the sum the TSS removed by all BMPs divided by the total TSS to be treated. The released water volume and the TSS remaining are both passed to the next downstream subcatchment.

### Pond Routing

Detention storage volume for flood control is computed by numerically routing the hydrograph for the developed site through a detention basin (pond). The steps in the process are as follows:

1. The inflow hydrograph is interpolated from a collection of scaled hydrographs computed using TR-20 for various times-of-concentration and the ratio of initial abstract to total rainfall (Ia/P) values. This is similar

to the tabular TR-55 approach. The hydrograph collection was generated using the Michigan specific dimensionless unit hydrograph.

2. Structural BMP volumes are removed from the front of the hydrograph, effectively reducing the required flood control volume. The resulting hydrograph does not start until all retention volume is satisfied.
3. The inflow hydrograph adjusted for structural BMPs is routed through a detention pond model using the Modified Puls Method (see Section 8.4.8 of the MDOT Drainage Manual). The pond is assumed to be prismatic and defined by a bottom area, side slope, and orifice diameter. Pond routing is the calculation of the outflow hydrograph given the inflow hydrograph and pond characteristics. This calculation is based on the continuity equation written in differential form:

$$\frac{dV}{dt} = I - Q$$

where  $V$  is the volume of water in storage in the pond at time  $t$ ,  $I$  is the inflow at time  $t$ , and  $Q$  is the outflow at time  $t$ . To calculate the outflow hydrograph, a finite difference method approximation of the continuity equation is used. This allows  $Q$  to be calculated as a time series:

$$\left( V_{i+1} + Q_{i+1} \frac{\Delta t}{2} \right) = (I_{i+1} + I_i - Q_i) \frac{\Delta t}{2} + V_i$$

where  $\Delta t$  is the time step,  $i+1$  refers to the present time and  $i$  refers to a time  $\Delta t$  earlier. At time  $i+1$  everything on the right hand side of the equation is known, allowing the value of the left hand side to be determined. Since  $V$  and  $Q$  are both functions of the pond depth,  $H$ , given the pond characteristics a table

that relates values of pond depth,  $H$ , to values of  $\left( V + Q \frac{\Delta t}{2} \right)$  can be constructed. This table is then used

to find the pond depth at time  $i+1$ . Given this pond depth, the storage volume,  $V$ , and outflow,  $Q$ , can also be computed at time  $i+1$ . The calculation can then proceed to the remaining time steps resulting in the outflow hydrograph.

4. The pond model characteristics include bottom area, side slope, and orifice diameter. The spreadsheet computes the required orifice diameter to produce the desired peak discharge at an arbitrary depth of 5 feet. The sides are conservatively assumed to be vertical.
5. The spreadsheet runs a macro that iteratively adjusts the bottom area until the desired peak discharge and storage depth are met.

### Application

The LGROW Design Spreadsheet can assist the Design Engineer in applying the correct land uses and Curve Numbers in calculating channel protection volume, accounting for travel time through BMPs, accounting for total TSS reduction from a series of BMPs, and quickly evaluating a variety of stormwater management options for a range of rainfall frequencies.

Design calculations submitted using the LGROW Design Spreadsheet can help to expedite the review process because reviewing engineers are familiar with the spreadsheet and can more quickly check that requirements are being met. Spreadsheet submittals shall include all printed output in pdf format accompanied by a complete working Excel file matching the printed output.

The spreadsheet is a tool for demonstrating compliance with standards. It is not a tool for designing BMPs. The Design Engineer is responsible for effective BMP design in accordance with best practices, requirements, and guidance provided herein.

Portions of the computational programming in the spreadsheet are not visible to the user. Users are encouraged to validate the spreadsheet output following the computational methods presented in the Documentation tab. The Design Engineer is responsible for their own calculations to demonstrate compliance with these standards.

# **Appendix 1**

## Application and Checklists

# APPLICATION FOR STORMWATER REVIEW

City of Grandville  
3195 Wilson Ave SW  
Grandville, MI 49418  
(616) 531-3030

## SITE INFORMATION

PROJECT NAME: \_\_\_\_\_

TOWNSHIP/CITY: \_\_\_\_\_ SECTION: \_\_\_\_\_ QUARTER SECTION: \_\_\_\_\_

PROJECT ADDRESS: \_\_\_\_\_ PARCEL NO.: \_\_\_\_\_

NO. OF ACRES: \_\_\_\_\_ NO. OF LOTS/UNITS (if applicable): \_\_\_\_\_

DEVELOPMENT TYPE:     \_\_\_ PLAT                   \_\_\_ SITE CONDOMINIUM     \_\_\_ CONDOMINIUM  
                             \_\_\_ APARTMENTS     \_\_\_ MOBILE HOME PARK     \_\_\_ INSTITUTIONAL  
                             \_\_\_ COMMERCIAL     \_\_\_ BUSINESS PARK     \_\_\_ PUD  
                             \_\_\_ INDUSTRIAL     \_\_\_ INDUSTRIAL PARK     OTHER: \_\_\_\_\_

REVIEW TYPE:     \_\_\_ PRIVATE                             REVIEW TYPE:     \_\_\_ PRE-APPLICATION MTG.  
                     \_\_\_ 433 AGREEMENT                             \_\_\_ PRELIMINARY PLAT  
                     \_\_\_ 425 AGREEMENT                             \_\_\_ CONSTRUCTION DWG.

## CONTACT INFORMATION

DEVELOPER: \_\_\_\_\_

MAILING ADDRESS: \_\_\_\_\_

CITY/STATE/ZIP: \_\_\_\_\_ PHONE: \_\_\_\_\_

CONTACT PERSON: \_\_\_\_\_ EMAIL: \_\_\_\_\_

ENGINEER: \_\_\_\_\_

MAILING ADDRESS: \_\_\_\_\_

CITY/STATE/ZIP: \_\_\_\_\_ PHONE: \_\_\_\_\_

CONTACT PERSON: \_\_\_\_\_ EMAIL: \_\_\_\_\_

## FEES MUST BE SUBMITTED WITH COMPLETED APPLICATION PRIOR TO PROCESSING

Pre-application Meeting/Requested Site Evaluation:     \$ \_\_\_\_\_

Preliminary Plat and Construction Dwg. Review:     County Drain Review:

Submittal Fee:     \$ \_\_\_\_\_                             Permit Fee:             \$ \_\_\_\_\_

Resubmittal Fee:     \$ \_\_\_\_\_                             Inspection Fee:         \$ \_\_\_\_\_

Review Deposit:     \$ \_\_\_\_\_                             Maintenance Fee:       \$ \_\_\_\_\_

# STORMWATER WORKSHEET

Project Name: \_\_\_\_\_ Location: \_\_\_\_\_

Developer/Owner: \_\_\_\_\_ Engineering Firm: \_\_\_\_\_

By (Design Engineer): \_\_\_\_\_ Date: \_\_\_\_\_

## Sensitive Areas:

Indicate on site plan and check below.

(Check all that apply)

- |  |  |   |
|--|--|---|
| <input type="checkbox"/> Waterbodies             | <input type="checkbox"/> Rivers and Streams              | <input type="checkbox"/> Floodplains          |
| <input type="checkbox"/> Riparian                | <input type="checkbox"/> Wetlands                        | <input type="checkbox"/> Woodlands            |
| <input type="checkbox"/> Sand Dunes              | <input type="checkbox"/> Natural Drainage Ways           | <input type="checkbox"/> Steep/Erodible Soils |
| <input type="checkbox"/> Susceptible Groundwater | <input type="checkbox"/> Threatened & Endangered Species |   |

## Special Site Considerations:

(Check all that apply)

- |                                   |   |   |
|-----------------------------------|---|---|
| <input type="checkbox"/> Hot Spot | <input type="checkbox"/> Coldwater Stream | <input type="checkbox"/> Policy Watershed |
| Activity: _____                   | Name: _____                               | Name: _____                               |

## Water Quality:

Required for all sites.

## Channel Protection:

Required for surface water discharges[not required for direct discharge to Lake Michigan and Spring Lake].

(Check all that apply)

- Onsite Retention (must be considered first and foremost).  
If site conditions preclude onsite retention:
- Off-site Mitigation.
- Payment-in-lieu (subject to availability).
- Alternative Approach: Extended Detention (submit Engineer's Certification).

## Flood Control:

Required for all sites.

(Check all that apply)

- Standard release rate (0.13 cfs/acre).
- Alternate release rate allowed (describe): \_\_\_\_\_
- Floodplain required in lieu of detention.

(Check one)

- Emergency Overflow Routes available and identified on site plan.
- No acceptable Emergency Overflow Routes (detention/retention sized for 2 times the flood control volume; storm sewer may be required to be upsized to 100-year design).

**Engineer’s Certification for Use of Alternative Approach for Channel Protection:**

I am the Design Engineer for \_\_\_\_\_ and certify that I have followed the LGROW Alternative Approach Flowchart, and maximized the use of BMPs to meet the channel protection volume standard through reduction of runoff and onsite retention. The following site constraints preclude meeting the channel protection standard through volume control:

(Check all that apply)

- Poorly draining soils (< 0.24 inches per hour infiltration capacity; typically HSG C and D).
- Part 201 and Part 213 sites, and areas of soil or groundwater contamination.
- High groundwater, or the potential of mounded groundwater to impair other uses.
- Wellhead protection areas.
- Bedrock.
- Other: \_\_\_\_\_

\_\_\_\_\_  
(Printed Name)

\_\_\_\_\_  
(Date)

\_\_\_\_\_  
(Signature)

\_\_\_\_\_  
(PE license no.)



# STORMWATER REVIEW CHECKLIST

Development Name: _____
Location: _____

Date: _____
Reviewed By: _____

**PRELIMINARY PLAT OR SITE PLAN DRAWINGS**

The following information shall be included on all preliminary plats or site plans submitted for approval. Sheets shall be no larger than 24" x 36" at a scale no smaller than 1" = 100' and prepared by a professional engineer or surveyor licensed in the State of Michigan.

The purpose of the preliminary review is to evaluate the development concept and assess stormwater impacts of the project on the surrounding area. Drawing submittal needs to include a "drainage map" with enough topographic information beyond the project limits to be able to evaluate grading and drainage impacts to offsite areas.

	<u>Provided/ Satisfactory</u>	<u>Comments</u>
<b>General</b>		
1. Development name/subdivision number.	_____	
2. North arrow, scale and legend.	_____	
3. Name, address, and telephone number of Proprietor.	_____	
4. Name, address, telephone number, signature, and seal of the Design Engineer (and/or surveyor).	_____	
5. Description of location (section and fractional portion thereof; town and range; township, city or village; county; state).	_____	
6. Location map.	_____	
7. Drainage map.	_____	
<b>Site Layout</b>		
8. The number of acres to be developed.	_____	
9. Development boundary with legal property description tied to government corners.	_____	
10. Identification of all adjoining parcels (for subdivisions show lot number, subdivision name, liber, and page numbers; for metes and bounds parcels show permanent parcel number).	_____	
11. Proposed street, alley, and lot layouts with dimensions (scaled or computed).	_____	
12. Lot numbers.	_____	
13. Building setback lines.	_____	

# STORMWATER REVIEW CHECKLIST

		<u>Provided/ Satisfactory</u>	<u>Comments</u>
<b>Easements</b>			
14.	Utility easements (with dimensions and type of utility).	_____	
15.	Existing drainage easements with dimensions and recording liber and page.	_____	
16.	Proposed drainage easements with dimensions.	_____	
<b>Existing Site Features</b>			
17.	Existing buildings (label those under construction with address).	_____	
18.	Existing roads (name, ROW width, and type of surface.	_____	
19.	Existing drainage structures (with proper labeling as to type, size, and invert elevations).	_____	
20.	The location and description of any other onsite and adjacent offsite features that may be relevant in determining the overall requirements for the development (e.g. railroads, high tension power lines, underground transmission lines, sanitary sewers, water mains, septic fields, wells, cemeteries and parks).	_____	
21.	Riparian buffers, natural flow pathways, wetlands, floodplains and other sensitive areas.	_____	
22.	Existing contours (no greater than 2' interval inside the plat; no greater than 10' interval outside the plat).	_____	
<b>Soils</b>			
23.	Soil type(s) from County Soil Survey.	_____	
24.	Soil borings indicating seasonally high groundwater elevations.	_____	
<b>Proposed Site Features</b>			
25.	Proposed contours.	_____	
26.	Proposed roads (label road as "Public Road" or "Private Road").	_____	
27.	Proposed drainage systems (clearly identify all open and enclosed portions) and preliminary layout of stormwater BMPs.	_____	

# STORMWATER REVIEW CHECKLIST

## CONSTRUCTION DRAWINGS

The following additional information shall be included on all construction drawings submitted for approval. Sheets shall be no larger than 24" x 36" at a scale no smaller than 1" = 50' and sealed by a professional engineer licensed in the State of Michigan.

		<u>Provided/ Satisfactory</u>	<u>Comments</u>
1.	Benchmark locations and elevations.	_____	_____
2.	Plans, profiles, cross-sections, and details of all roads, storm sewers, footing drain laterals, open channel drains and other stormwater BMPs.	_____	_____
3.	Details of storm sewer and culverts shall include: numbering of manholes/catchbasins, invert and casting elevations, pipe length (center-to-center of structure), pipe diameter, pipe material, pipe slope, pipe class, pipe joints, special backfill and bedding, inlet/outlet protection, profile of the hydraulic grade line.	_____	_____
4.	Details of outlet control structures (scaled detail with hydraulic information matching calculations; schematic design sketches are unacceptable).	_____	_____
5.	Lot grading plan (detail, statement, or drainage arrows).	_____	_____
6.	Minimum opening and basement elevation for each lot.	_____	_____
7.	Plans and details of SESC measures and staging.	_____	_____
8.	Protected sensitive areas, minimal disturbance areas and other "non-structural" BMPs.	_____	_____
9.	Location of all proposed drain fields. (Drain fields shall comply with isolation distance requirements.)	_____	_____

# STORMWATER REVIEW CHECKLIST

## DESIGN CALCULATION PACKAGE

Completed by a professional engineer licensed in the State of Michigan.

		<u>Provided/ Satisfactory</u>	<u>Comments</u>
1.	Completed Stormwater Worksheet.	_____	
2.	A topographic map with site delineated in relation to watershed.	_____	
3.	Calculations of peak discharge for a range of storms up to and including the 100-year storm for any natural water courses and/or county drains passing through the proposed development, including area of upstream watershed.	_____	
4.	Normal, design and 100-year water elevations, including overland flow routes shown on the topographic map.	_____	
5.	A drainage area map that clearly shows subcatchment boundaries, acreages and flow paths of tributary areas to each point of discharge from the development, including tributary areas originating outside of the development. Also identify tributary areas to inlets, culverts, and other storm water BMPs.	_____	
6.	Documentation and/or calculations required to demonstrate an adequate outlet, including the sizes and locations of upstream and downstream culverts serving drainage routes into and out of the development site.	_____	
7.	Calculations of stormwater rates and volumes for each point of discharge or treatment train for pre-development and post-development conditions for the design storms.	_____	
8.	BMP design calculations.	_____	
9.	Groundwater mounding calculations (when required).	_____	
10.	Design summary report, including at a minimum: description of stormwater management plan for the site, identified contributing areas with land cover types, soils and runoff coefficients, times-of-concentration, runoff volumes, peak discharges, design high water levels, sewer hydraulic grade line, required storage volumes, and volumes provided.	_____	

# STORMWATER REVIEW CHECKLIST

## MAINTENANCE ASSURANCE

The Design Engineer shall incorporate considerations for access, operation and maintenance into the design of all stormwater BMPs to ensure the stormwater system can be readily maintained. Specific minimum requirements are included on individual BMP design criteria sheets. The following information must be shown on the construction drawings at a minimum, and clearly identified on a separate set of drawings submitted for review:

		<u>Provided/ Satisfactory</u>	<u>Comments</u>
1.	Identified access routes for trucks and maintenance equipment, including fences and gates.	_____	_____
2.	Proper siting of BMPs for accessibility.	_____	_____
3.	Design of BMP elements to minimize amount of maintenance required (e.g. filters on small orifices, design of trash racks to facilitate debris removal, etc.).	_____	_____
4.	Design details to illustrate maintenance features (e.g. removable grates or rails, locks, access platforms, etc.).	_____	_____
5.	Identified areas for staging and temporary spoil disposal.	_____	_____

## CONSTRUCTION RECORD DRAWINGS

Completed by a professional engineer licensed in the State of Michigan.

A final set of drawings, updated and marked “issued for construction record” with date in revision block, must be received before release of any security on deposit.

		<u>Provided/ Satisfactory</u>	<u>Comments</u>
1.	Horizontal location of all drainage structures and footing drain connection points relative to a coordinate point or lot corner. Alternately, locations may be shown by road stationing with offsets.	_____	_____
2.	Final grading and volume of all detention/retention facilities and integrated BMPs with verification that they meet or exceed approved storage and infiltration capacities.	_____	_____
3.	Pipe inverts, length and slope, manhole and catch basin rims, top of berm, and spillway elevations.	_____	_____
4.	Details of inlet structures (including opening areas and elevations.)	_____	_____

# STORMWATER REVIEW CHECKLIST

## GIS DIGITAL SUBMISSION REQUIREMENTS

Required for final plats, construction record drawings and drainage district maps.

1. All files must be in a .dxf format.
2. All submitted files must be zipped to ensure they arrive intact.
3. Email or compact disc are acceptable ways to receive files.

Technical Requirements:

1. All lines must be snapped closed (no dangles, overstrikes, or understrikes).
2. Layers must have a reasonable label of what can be found on each layer.
3. The following separate layers must be included:
  - a. Lot Numbers.
  - b. Lot Lines.
  - c. Lot Dimensions.
  - d. Right-of-Way Dimensions.
  - e. Right-of-Way Names.
  - f. Subdivision Boundaries.
  - g. Water/Storm/Hydrants/Sewer Lines/Culverts.
  - h. Easements.
  - i. Easement Dimensions.
  - j. Contours.
  - k. Any other features of value in determining overall drainage requirements.
4. Lot and right-of-way dimension layers must have nothing more than leaderlines.
5. Hatching must be on one layer with no other items.
6. Layout design and any tables must be in one layer.

COMMENTS:

---

---

---

---

---

# SUBMITTAL CHECKLIST

(Private Development)

Development Name: _____
Location: _____

Date: _____
Reviewed By: _____

**Initial Reviews**

1. PRELIMINARY: Preliminary site plan, application and fees (submittal fee and review deposit).
2. CONSTRUCTION: Construction drawings, application, calculation package and fees (submittal fee and review deposit if preliminary review omitted).

**Prior to Construction Drawing Approval**

3. Copies of Restrictive Covenant or Master Deed language.
4. Recordable rights-of-way for downstream properties or flooding easement agreement.
5. Approval has been given for any maintenance required to existing county drains.
6. Copy of Maintenance Agreement between Proprietor and municipality (Required for urbanized areas, and may be required by municipality for other areas).
7. All additional fees paid for engineering review.

**Upon Completion of Construction and Prior to Release of Review Deposit**

8. Copies of recorded Restrictive Covenants or Master Deed and easements, including certification by Design Engineer relative to lowest floor and opening elevations.
9. Copy of recorded Maintenance Agreement.
10. Construction record drawings (As-builts) and Design Engineer's As-built Certification.
11. Certification by Design Engineer that county drains have been maintained in accordance with approved construction drawings.
12. Drain Commissioner releases remaining review deposit (posted per item no. 1 or 2).

	<u>Date Received</u>	<u>Date Accepted</u>
	_____	_____
	_____	_____
	_____	_____
	_____	_____
	_____	_____
	_____	_____
	_____	_____
	_____	_____
	_____	_____
	_____	_____
	_____	_____

# SUBMITTAL CHECKLIST

(County Drain)

Plats, site condominiums and other multi-lot developments with public roads, developments with a downstream drainage course to be established as a county drain, or a downstream drainage course that needs to be improved or added as a branch/extension of an existing county or intercounty drain.

Development Name: _____
Location: _____

Date: _____
Reviewed By: _____

**Initial Reviews**

1. PRELIMINARY: Preliminary Plat or site plan, application, and fees (submittal fee and review deposit).
2. CONSTRUCTION: Construction drawings, application, calculation package and fees (submittal fee and review deposit if preliminary review omitted).

**Prior to Construction Drawing Approval**

3. Specifications for public drainage system components.
4. Copies of Restrictive Covenant or Master Deed language, including certification by Design Engineer relative to lowest floor and opening elevations.
5. Recordable release of rights-of-way within the Plat or development provided in the name of the drainage district.
6. Recordable release of rights-of-way for downstream properties, or flooding easement agreement.
7. Certification by Design Engineer of adequacy of receiving drains.
8. Drain permit application and fee.
9. A drainage district has been established (or adjusted) and a 433 Agreement submitted; OR  
 A 425 Application has been submitted if adding a branch, relocating, or tiling a drain located entirely within an existing drainage district; OR  
 A letter of commitment from the local municipality, governmental agency, or association has been executed.
10. All additional fees paid for engineering review.

	<b>Date Received</b>	<b>Date Accepted</b>



# SUBMITTAL CHECKLIST

(County Drain)

## Prior to Construction

- 11. Itemized cost of construction for county drain work.
- 12. Performance surety (not required for Plats signed after construction is completed).

## When Drain Commissioner Signs Final Plat Prior to Completion of Construction

- 13. The Proprietor has entered into an agreement with the Drain Commissioner and has posted surety (item 12) for faithful performance of the agreement.

## Upon Completion of Construction

- 14. Inspection reports (for work on county drain only).
- 15. Final acceptance of county drain by Drain Commissioner.
- 16. Acceptance of roads by County Road Commission (for public roads only).
- 17. Certification that county drains and storm water system have been improved in accordance with approved construction drawings (Design Engineer's As-built Certification).
- 18. Construction record drawings (As-builts).

## Prior to Final Plat Approval or Release of Surety

- 19. Evidence of municipal approval of Preliminary Plat.
- 20. Copy of recorded Restrictive Covenants or Master Deed Liber \_\_\_\_ Page \_\_\_\_.
- 21. Recorded Easements Liber \_\_\_\_ Page \_\_\_\_.
- 22. Recorded 433 Agreement Liber \_\_\_\_ Page \_\_\_\_.
- 23. Route and Course Description (for county drain).
- 24. Drainage District Map and legal description.
- 25. Copy of recorded Maintenance Agreement (if association or corporate entity wishes to perform routine maintenance).
- 26. Maintenance fee (per Section 433).
- 27. Drain Commissioner signs Final Plat.
- 28. Drain Commissioner returns remaining review deposit and surety (posted per items 1 and 12).

## **Appendix 2**

# **Watershed Policy Statements**

Watershed policy statements will be added to this document as they are developed.

**Appendix 3**

**BMP Design Criteria for Stormwater Controls**

## Table of Contents – Appendix 3

I.	Non-Structural Best Management Practices .....	1
A.	Minimal Disturbance Area .....	2
B.	Protect Natural Flow Pathways.....	3
C.	Protect Sensitive Areas .....	4
D.	Native Revegetation.....	5
E.	Stormwater Disconnect.....	6
II.	Structural Best Management Practices .....	7
A.	Storm Sewer .....	8
B.	Culvert or Bridge .....	11
C.	Open Channel.....	12
D.	Detention Basins .....	14
E.	Retention Basins.....	23
F.	Infiltration Practices .....	29
G.	Bioretention/Rain Garden.....	35
H.	Constructed Filter.....	39
I.	Planter Box .....	42
J.	Pervious Pavement.....	45
K.	Capture Reuse .....	48
L.	Vegetated Roof .....	50
M.	Water Quality Device .....	51
N.	Sediment Forebay .....	52
O.	Spill Containment Cell .....	53
P.	Bioswale and Water Quality Swale .....	56
Q.	Vegetated Swale.....	61
R.	Vegetated Filter Strip .....	63
S.	Level Spreader.....	68

### List of Tables

Table 12 – Manning’s Roughness Coefficients .....	9
Table 13 – Minimum and Maximum Slopes for Storm Sewers .....	9
Table 14 –Hydraulic Conductivities for Filter Media .....	40
Table 15 – Permanent Stabilization Treatment for Vegetated Swales .....	62

### List of Figures

Figure 3 – Manning’s Roughness Coefficients for Vegetated Swales.....	61
Figure 4a – Filter Strip Length (Sandy soils with HSG A) .....	65
Figure 4b1 – Filter Strip Length (Sandy Loam soils with HSG B).....	65
Figure 4b2 – Filter Strip Length (Loam, Silt-Loam soils with HSG B) .....	65
Figure 4c – Filter Strip Length (Sandy Clay Loam soils with HSG C) .....	66
Figure 4d – Filter Strip Length (Clay Loam, Silty Clay, Clay soils with HSG D) .....	66

## I. NON-STRUCTURAL BEST MANAGEMENT PRACTICES

Non-structural BMPs consist of protection measures that reduce the volume of stormwater runoff from the site. This differs from the goal of many structural BMPs which is to help mitigate the impact of stormwater runoff.

Design criteria is provided for the following non-structural BMPs:

- A. Minimal Disturbance Area
- B. Protect Natural Flow Pathways
- C. Protect Sensitive Areas
- D. Native Revegetation
- E. Stormwater Disconnect

Further information and examples are provided in the BMP Fact Sheets in [Chapter 6](#) of the *Low Impact Development Manual for Michigan* (SEMCOG, 2008):

All of the following criteria must be met to receive credit for each non-structural BMP selected for use.

## A. Minimal Disturbance Area

### 1. Summary

Description:	Identify and avoid disturbance to existing pervious areas during construction to reduce potential for erosion and increased runoff.
Application:	Larger sites with pervious areas; difficult to implement on small, high-density developments.
Pretreatment Required:	No.
Maintenance Plan:	Yes, for trees receiving a credit.
Calculation Credits:	
Volume Reduction:	Assign a CN reflecting open space in “good” condition, or woods in “good” condition, or a combination. For small sites, individual trees can receive a credit of 800 square feet per tree, counted as woods in “good” condition. <sup>1</sup>
Rate Reduction:	By virtue of lower CN.
Water Quality:	Exempt from water quality criteria.

<sup>1</sup>Source: *Low Impact Development Manual for Michigan* (SEMCOG, 2008).

*Note:* Trees in minimal disturbance areas receive a larger area credit than trees planted under “Native Revegetation” due to the assumption that the existing trees will typically be larger and more mature than planted trees at the time of site plan submittal and during ensuing years.

### 2. Criteria

This BMP applies to those portions of buildable lots located outside of lot building zones, construction traffic areas, and staging areas that can be maintained as “minimal disturbance areas” during construction (i.e. wooded back portions of residential lots, green space required by ordinance).

Minimal disturbance area – Construction disturbance is limited to clearing of brush and minor grading. No clear-cutting, excavation, filling, stockpiling of material, or construction traffic is allowed. Area is vegetated after disturbance (if any).

- a. Identify minimal disturbance areas on site plan and construction drawings.
- b. Minimal disturbance areas must be protected by having the limits delineated/flagged/fenced in the field. Notes to this effect must be included on construction drawings.
- c. Minimal disturbance areas must not be subject to excessive equipment movement. Vehicle traffic and storage of equipment and/or materials is not permitted.
- d. Pruning or other required maintenance of vegetation is permitted. Additional planting with site-appropriate plants including turf grass is permitted.
- e. Areas receiving credit must be located on the development project.

## B. Protect Natural Flow Pathways

### 1. Summary

Description:	Identify and map natural drainage features to maximize protection and benefits of use.
Application:	Lower-density developments.
Pretreatment Required:	No. This BMP can provide pretreatment.
Maintenance Plan:	Yes.
Calculation Credits:	
Volume Reduction:	Assign a CN reflecting a meadow or open spaces in “good” condition.
Rate Reduction:	Due to longer time-of-concentration for natural flow pathway.
Water Quality:	Exempt from water quality criteria.

### 2. Criteria

- a. Identify all existing natural flow pathways on site plan.
- b. Identify natural flow pathways to be protected on site plan and construction drawings.
- c. Protected natural flow pathways on private property must have an easement or deed restriction to prevent future disturbance or neglect.
- d. Natural flow pathways to be protected must have the limits delineated/flagged/fenced in the field. Notes to this effect must be included on construction drawings.
- e. Identify flow pathways designed as part of the stormwater management system including strategies such as:
  - (1) Increased length.
  - (2) Increased roughness.
  - (3) Decreased slope.
- f. Ensure adequacy of flow pathway for post-development flows.

## C. Protect Sensitive Areas

### 1. Summary

Description:	Identify, map and prioritize sensitive areas on the site to be preserved and protected in perpetuity.
Application:	Plats; Condominiums; More difficult to implement as development density increases.
Pretreatment Required:	No.
Maintenance Plan:	No.
Calculation Credits:	Remove protected sensitive areas from stormwater management calculations, or select an appropriate existing land use if necessary to include the area for sizing of conveyance systems.
Volume Reduction:	Exempt from channel protection criteria.
Rate Reduction:	Exempt from flood control criteria.
Water Quality:	Exempt from water quality criteria.

### 2. Criteria

This BMP includes protected areas on the development property located on separate out lots or set-asides with language in the master deed or bylaws that requires protection and preservation, and that restricts land uses to those that do not increase runoff.

- a. Identify all sensitive areas on site plan.
- b. Identify all sensitive areas to be protected on the site plan and construction drawings.
- c. Sensitive areas to be protected must have the limits delineated/flagged/fenced in the field during construction and visible permanent boundary markers set to minimize encroachment (as appropriate). Notes and details to this effect must be included on construction drawings.
- d. Identify municipal ordinance requirements, if any, and incorporate sensitive area standards for development site. In the absence of a local ordinance, standards for riparian buffers shall consist of:
  - (1) Variable width depending on topography, minimum 25-foot width (Zone 1).
  - (2) Naturally vegetated.
- e. Minimal clearing is allowed for lot access and fire protection.
- f. For activities proposed within floodplains the Developer shall demonstrate any activity proposed within a 100-year floodplain will not diminish the flood storage capacity. Compensatory storage will be required at a minimum ratio of one-to-one (1:1) for all lost floodplain storage.
  - (1) The compensating cut must be available during a flood event.
  - (2) Water must be able to move freely from stream to storage.
  - (3) Excavation must be adjacent to the floodplain.
  - (4) Flood storage must be between the 2-year flood elevation and the 100-year flood elevation.
  - (5) Compensating storage shall NOT be provided through channel widening.



## D. Native Revegetation

### 1. Summary

Description:	Restoration of disturbed pervious areas with deeper-rooted native plants in lieu of conventional turf grass to reduce runoff volume.
Application:	All development types; Limitations where rapid establishment of dense turf grass is needed to prevent erosion in concentrated flow situations.
Pretreatment Required:	No. This BMP can provide pretreatment.
Maintenance Plan:	Yes.
Calculation Credits:	
Volume Reduction:	Assign a CN reflecting a meadow. For small sites, individual trees can receive a credit of 200 square feet per tree, counted as woods in “good” condition. <sup>1</sup>
Rate Reduction:	By virtue of lower CN.
Water Quality:	Exempt from water quality criteria.

<sup>1</sup>Source: SEMCOG (2008). *Low Impact Development Manual for Michigan*.

*Note:* Trees in minimal disturbance areas receive a larger area credit than trees planted under “Native Revegetation” due to the assumption that the existing trees will typically be larger and more mature than planted trees at the time of site plan submittal and during ensuing years.

### 2. Criteria

- a. Identify native revegetation areas on site plan and construction drawings.
- b. Native revegetation areas must be protected by having the limits delineated/flagged/fenced in the field. Notes to this effect must be included on construction drawings.
- c. Standards shall consist of:
  - (1) Variable width depending on topography, minimum 25-foot width (Zone 1).
  - (2) Native revegetation selected from the *Low Impact Development Manual for Michigan* (SEMCOG, 2008), [Appendix C](#).
- d. Areas receiving credit must be located on the development project.

## E. Stormwater Disconnect

### 1. Summary

Description:	Minimize runoff volume by disconnecting impervious areas from the stormwater conveyance system.										
Application:	Rooftops; Driveways; Walkways; Patio areas; Minor roads.										
Pretreatment Required:	No.										
Maintenance Plan:	Yes.										
Calculation Credits:											
Volume Reduction:	<p>Weight impervious CN with pervious area CN for open spaces in “good” condition. The following weighted CNs can be assigned to the disconnected impervious area. They assume a pervious area twice the size of the impervious area.</p> <table border="1"> <thead> <tr> <th>A</th> <th>B</th> <th>C</th> <th>D</th> </tr> </thead> <tbody> <tr> <td>59</td> <td>73</td> <td>82</td> <td>86</td> </tr> </tbody> </table>			A	B	C	D	59	73	82	86
A	B	C	D								
59	73	82	86								
Rate Reduction:	By virtue of weighted CN.										
Water Quality:	Exempt from water quality criteria.										

### 2. Criteria

- a. Stormwater from rooftops and other impervious areas is considered disconnected if it is routed to a stabilized vegetated area, or an onsite depression storage area that meets the following criteria:
  - (1) Pervious area is not a structural BMP that must be designated to treat the runoff from the impervious surface.
  - (2) Impervious area must be limited to 1,000 square feet per discharge point.
  - (3) Roof downspouts and curb cuts must be at least 10 feet away from the nearest connected impervious surface to discourage “re-connections.”
  - (4) Disconnection in less permeable soils (HSGs C and D) may require the use of dry wells, french drains, or other temporary storage device to compensate for poor infiltration capability if ponding of water for extended period of time becomes problematic.
  - (5) For disconnects to stabilized vegetated areas:
    - (a.) Size of disconnect area shall be twice the size of the contributing impervious area.
    - (b.) Length of disconnect area must be at least the length of the flow path of the contributing impervious area (maximum 75 feet).
    - (c.) Slope of disconnect area must be no greater than 5%.
    - (d.) Disconnect area may be a “minimal disturbance area.”
  - (6) Disconnection must ensure no basement seepage.
- b. Identify disconnect areas on site plan and construction drawings.

## II. STRUCTURAL BEST MANAGEMENT PRACTICES

Structural BMPs are constructed measures that convey, store and treat stormwater in a site-specific location and help mitigate the impact of stormwater runoff.

Design criteria is provided for the following structural BMPs:

### Conveyance and Storage

- A. Storm Sewer
- B. Culvert or Bridge
- C. Open Channel
- D. Detention Basins
- E. Retention Basins

### LID and Small Site

- F. Infiltration Practices
- G. Bioretention/Rain Garden
- H. Constructed Filter
- I. Planter Box
- J. Pervious Pavement
- K. Capture Reuse
- L. Vegetated Roof
- M. Water Quality Device
- N. Sediment Forebay
- O. Spill Containment Cell
- P. Bioswale and Water Quality Swale
- Q. Vegetated Swale
- R. Vegetated Filter Strip
- S. Level Spreader

BMPs shall be designed in accordance with these standards.

Further information and examples for LID and Small Site BMPs are provided in the BMP Fact Sheets in [Chapter 7](#) the *Low Impact Development Manual for Michigan* (SEMCOG, 2008).

*Note:* Design criteria for BMPs used primarily for soil erosion and sedimentation control and channel stabilization (i.e. riprap, in-stream structures, natural channel design), and technical specifications for construction are beyond the scope of this manual.

## A. Storm Sewer

### 1. Summary

Description:	Provides stormwater conveyance in an enclosed system.
Application:	Urban areas; Where above-ground conveyance is not desirable.
Types:	Pipe (solid wall, perforated).
Pretreatment Required:	No. This BMP can provide spill containment.
Maintenance Plan:	Yes.
Calculation Credits:	
Volume Reduction:	Solid wall pipe: None. Perforated pipe (with slope): None.
Rate Reduction:	None.
Water Quality:	Count volume routed through catch basin.

### 2. Design Requirements

#### a. Sizing and Configuration

- (1) Storm sewer shall be designed to convey the peak discharge from a 10-year rainfall event.
- (2) A dual or redundant storm sewer may be required to convey the peak discharge from a 100-year rainfall event if acceptable overland flow routes do not exist (refer to Part 3 section “Flood Control”).
- (3) Design velocities, capacities, and friction losses shall be based on Manning's equation:

$$Q = \frac{1.49AR^{\frac{2}{3}}S^{\frac{1}{2}}}{n} \quad (4.21)$$

where:

- $Q$  = discharge (cubic feet per second)
- $A$  = wetted area (square feet)
- $R$  = hydraulic radius (feet)
- $S$  = slope (feet per foot)
- $n$  = Manning's Roughness Coefficient

- (4) Manning's coefficients for closed conduit are included in **Table 12**.
- (5) Acceptable slopes for circular pipe ("n" = 0.013) are included in **Table 13**. Minimum and maximum grade for other Manning's n values must be calculated based on allowable minimum and maximum velocities (V).
- (6) As a general rule, surcharging the pipe will be allowed to 1 foot below the top of casting. However, minor losses must be considered in hydraulic grade line calculations.
- (7) Storm sewer pipe shall have a minimum diameter of 12 inches. Smaller pipe may be approved for private systems or unique situations.
- (8) The minimum depth of cover shall be 24 inches from grade to the top of pipe.

#### b. End Treatment

- (1) Outlet pipes shall require energy dissipation. Riprap protection or equivalent erosion control measures shall be used where the velocity exceeds 4 feet per second, up to maximum allowable design velocity of 8 feet per second.

**Table 12 – Manning’s Roughness Coefficients**

Conduit	Coefficients
<b>Closed Conduits</b>	
Asbestos-Cement Pipe	0.011 to 0.015
Brick	0.013 to 0.017
Cast Iron Pipe (Cement-lined and seal-coated)	0.011 to 0.015
Concrete (Monolithic)	
Smooth forms	0.012 to 0.014
Rough forms	0.015 to 0.017
Concrete Pipe	0.011 to 0.015
Corrugated-Metal Pipe (1/2-inch corrugated)	0.022 to 0.026
Paved invert	0.018 to 0.022
Spun asphalt-lined	0.011 to 0.015
Plastic Pipe (Smooth)	0.011 to 0.015
Vitrified Clay Pipes	0.011 to 0.015
Liner channels	0.013 to 0.017
<b>Open Channels</b>	
Lined Channels	
Asphalt	0.013 to 0.017
Brick	0.012 to 0.018
Concrete	0.011 to 0.020
Rubble or riprap	0.020 to 0.035
Vegetal	0.030 to 0.040
Excavated or Dredged	
Earth, straight and uniform	0.020 to 0.030
Earth, winding, fairly uniform	0.025 to 0.040
Rock	0.030 to 0.045
Unmaintained	0.050 to 0.140
Natural Channels (streams, top width at flood state <100 feet)	
Fairly regular section	0.030 to 0.070
Irregular section with pools	0.040 to 0.100
Source: American Society of Civil Engineers and the Water Pollution Control Federation (1969). <i>Design and Construction of Sanitary and Storm Sewers</i> .	

**Table 13 – Minimum and Maximum Slopes for Storm Sewers**

Pipe Size (inches)	Minimum % of Grade (Velocity = 2.5 feet per second)	Maximum % of Grade (Velocity = 10 feet per second)
12	0.32	4.88
15	0.24	3.62
18	0.20	2.84
21	0.16	2.30
24	0.14	1.94
27	0.12	1.66
30	0.10	1.44
36	0.08	1.12
42	0.06	0.92
48	0.06	0.76
54	0.04	0.60
60	0.04	0.54
66	0.04	0.48
Manning’s “n” = 0.013		

## c. Manholes and Catch Basins

- (1) Manhole spacing shall not exceed 350 feet for sewers.
- (2) Manholes shall be placed at all changes in pipe direction, slope, pipe size, all inlet connection locations, and at the upper end of the storm sewer.
- (3) Where possible, pipe inverts at junctions shall be designed to minimize junction losses (match 0.8 points of pipe diameters).
- (4) All backyard yard basins and manholes shall be 4' in diameter, if the depth is equal to or greater than 4 feet; otherwise a 2' diameter is acceptable.
  - i. Note for yard grates: the Kent County Drain Commission recommends EJIW#6508 for contributing flow up to 5 cfs, and EJIW#6488 for anything above 5 cfs
- (5) Within road right-of-way, minimum inside diameter of all manholes, catch basins, and inlet structures shall be 48 inches, except that a 24-inch diameter structure may be allowed for structures with a single 12-inch outlet pipe, or when physical restriction does not accommodate a 48 inch catch basin.
- (6) All structures receiving direct surface water runoff shall have a sump not less than 24-inches deep.
- (7) Catch basins shall be placed at low points of streets and yards. Spacing and/or number of inlet structures required to accommodate the design flows in streets, private drives, and parking areas shall be provided based on inlet capacity with no ponding occurring during a 10-year storm, and the following additional stipulations:
  - (a.) No more than 350 feet of pavement surface drainage will be allowed. No more than 200 feet of surface drainage will be allowed for grades exceeding 4%.
  - (b.) Consideration shall be given to pedestrian crossings when siting catchbasins in intersections. Catchbasins shall be placed upstream of pedestrian crossings when practical.
  - (c.) No more than 150 feet of street drainage will be allowed to flow around a corner.
  - (d.) No flow will be allowed across a public street intersection.

## d. Materials

- (a) Storm sewer pipe shall be reinforced concrete or smooth interior wall polyethylene in accordance with MDOT Standard Specifications. Other materials shall be subject to approval.
- (b) Pipe joints shall be designed to prevent excessive infiltration or exfiltration.
- (c) Manholes and catch basins shall be in accordance with MDOT Standard Specifications.
- (d) Connections to manholes shall be made with a resilient connector for pipe diameters 24 inches or less. Concrete pipe connections shall be made by grouting the inside and outside wall of the structure.

## e. Utility Crossings

- (a) Meet utility vertical clearance standards of the municipal authority.

## B. Culvert or Bridge

### 1. Summary

Description:	Provides stormwater conveyance through a crossing structure.
Application:	Where crossing of open channels, wetlands, waterbodies, and grassed swales is required. Culverts can also provide equalization and outlet control.
Types:	Pipe Culvert; Box Culvert; Bridge.
Pretreatment Required:	No.
Maintenance Plan:	Yes.
Calculation Credits:	
Volume Reduction:	None.
Rate Reduction:	None.
Water Quality:	None.

### 2. Design Requirements

#### a. Sizing and Configuration

- (1) Bridges shall be designed to provide a 4.3-foot minimum underclearance at normal flow for canoe traffic on navigable waterways, and a 2-foot minimum freeboard to the underside (low chord) of the bridge for a 100-year flood where conditions allow.
- (2) Culverts serving a drainage area of less than 2 square miles shall be designed for the 25-year peak discharge in the developed watershed with a maximum outlet velocity of 8 feet per second. A maximum of 1 foot of inlet submergence may be permitted if this does not backup water out of the easement.
- (3) The effect of the 100-year storm shall be reviewed to ensure no adverse increase in water elevation off of the development property or flooding of structures within the development.
- (4) Sizing of culverts and bridges shall be performed using the Bernouli Equation and include consideration of inlet and outlet control, entrance and exit losses, and tailwater condition. Published culvert nomographs and other computer software may be used. Downstream structure size and capacity should also be considered.
- (5) Minimum diameter of a drive culvert shall be 12 inches.
- (6) Minimum diameter of a road crossing culvert shall be 15 inches or equivalent pipe arch.

#### b. End Treatment

- (1) Headwalls, wingwalls, and all other end treatments shall be designed to ensure the stability of the surrounding soil. MDOT, County Road Commission, or manufacturer's designs may be used.
- (2) Riprap protection or equivalent erosion control measures shall be used where the velocity exceeds 4 feet per second, up to maximum allowable design velocity of 8 feet per second.

#### c. Materials

- (1) Culverts may be reinforced concrete pipe, HDPE, corrugated steel pipe, or pipe arch in accordance with MDOT Standard Specifications. Smooth interior wall polyethylene may also be allowed.

## C. Open Channel

### 1. Summary

Description:	Stormwater conveyance in an excavated channel.
Application:	Larger drainage areas with concentrated runoff.
Types:	Channel; Ditch.
Pretreatment Required:	No.
Maintenance Plan:	Yes.
Calculation Credits:	
Volume Reduction:	None.
Rate Reduction:	None.
Water Quality:	None.

### 2. Design Requirements

#### a. Sizing and Configuration

- (1) The open channel shall be designed to convey the 25-year peak discharge.
- (2) Open channel design velocities, capacities, and friction losses shall be based on Manning's equation:

$$Q = \frac{1.49AR^{\frac{2}{3}}S^{\frac{1}{2}}}{n} \quad (4.21)$$

where:

- $Q$  = discharge (cubic feet per second)
- $A$  = wetted area (square feet)
- $R$  = hydraulic radius (feet)
- $S$  = slope (feet per foot)
- $n$  = Manning's roughness coefficient

- (3) Manning's Coefficients shall be determined from **Table 12**. A minimum Manning's Coefficient of 0.035 shall be used for open channels, unless special treatment is given to the bottom and sides (riprap, paving, mown sod, etc.).
- (4) Minimum bottom width shall be 2 feet.
- (5) Minimum longitudinal slope shall be 0.10%.
- (6) Side slopes shall be no steeper than 3:1 (horizontal to vertical). If regular mowing is required, side slope shall be 4:1. Bank heights greater than 6 feet shall be benched to provide for equipment access and/or erosion control.
- (7) The minimum velocity for open channels during the design event shall be 1.5 feet per second.
- (8) The maximum velocity shall be 4 feet per second. Riprap protection or equivalent shall be used where the velocity exceeds 4 feet per second, up to maximum allowable design velocity of 8 feet per second.

#### b. Connections and Crossings

- (1) Outlets into the open channel shall enter at an angle of 90 degrees or less with the direction of flow.



- (2) A minimum clearance of 4 feet is required between open channel inverts and underground utilities unless special provisions are approved.

## D. Detention Basins

### 1. Summary

Description:	Provides stormwater storage with a surface outlet.
Application:	Practical for a wide range of applications including large sites.
Types:	Dry Basin; Underground Vault; Extended Detention Basin; Wet Pond; Constructed Wetland.
Pretreatment Required:	Yes.
Maintenance Plan:	Yes.
Calculation Credits:	
Volume Reduction:	None.
Rate Reduction:	Calculated release rate.
Water Quality:	Count volume routed through BMP.

### 2. Sizing Calculations

- a. Calculate the allowable release rate and the required storage volume for flood control (refer to Part 4 section “Calculating Storage Volumes and Release Rates, Flood Control, Detention”).
- b. Extended detention volume provided for water quality treatment and/or channel protection may be included in the flood control volume. Where channel protection and water quality treatment are provided through upstream retention BMPs, these volumes may be subtracted from the total inflow volume.
- c. Size forebay(s) for pretreatment (refer to Part 4 section “Calculating Storage Volumes and Release Rates, Pretreatment”).
- d. Detention basins without an acceptable surface water overflow route shall be designed for 2 times the required flood control volume.

### 3. Design Requirements

- a. Siting
  - (1) Soil borings are required (refer to Part 4 section “Soils Investigation”).
    - (a.) A minimum of 3 feet is required between the bottom of dry detention basins and the highest known groundwater elevation.
    - (b.) Wet ponds and constructed wetlands shall have a reliable supply of baseflow or groundwater to support a permanent pool.
    - (c.) A constructed wetland must have a minimum contributing drainage area of 10 acres (5 acres for a pocket wetland).
    - (d.) Wet ponds and constructed wetlands proposed in HSG A and HSG B soils above the groundwater table shall have a clay or synthetic liner to minimize infiltration.

- (2) Setbacks shall be as follows:
  - (a.) Adjacent property line: 10 feet.
  - (b.) Building foundation: 30 feet.
  - (c.) Private well: 50 feet.
  - (d.) Public well: 200 feet from Type I or Type IIa wells, 75 feet from Type IIb or Type III wells (Safe Drinking Water Act, Act 399, PA 1976).
  - (e.) Septic system drainfield: 100 feet.
  - (f.) Airport: Per Federal Aviation Administration guidelines (wet pond, constructed wetland).
- b. Configuration
  - (1) General
    - (a.) Distances of flow paths between inlets and outlets shall be maximized. A minimum basin length-to-width ratio of 2 to 1 is required.
    - (b.) If site constraints preclude placing pipes at opposite ends of the basin or meeting the length-to-width ratio, baffles (berms) may be used to lengthen the flow path.
    - (c.) Where steeper side slopes than those specified are unavoidable, safety railing, fencing, or other access barriers may be approved.
  - (2) Dry Basin
    - (a.) The design high water depth should generally not exceed 10 feet above the bottom of the basin.
    - (b.) Where basins are to be maintained as a mown lawn, side slopes shall be no steeper than 4:1 (H:V) to facilitate mowing.
    - (c.) The bottom of dry detention basins shall be graded to provide positive flow to the pipe outlet. A minimum longitudinal bottom slope of 1% shall be provided. Cross slopes shall be 2% minimum. If continuous flow is anticipated, a low-flow channel shall be provided, with necessary crossings, and sloped to eliminate standing water. If site grades prohibit achieving these minimum slopes, the use of an underdrain with flatter slopes may be approved.
  - (3) Wet Pond
    - (a.) At a minimum, the volume of the permanent pool for wet ponds shall be 2.5 times the water quality volume to account for reduced settling efficiency due to turbulence caused by wind.
    - (b.) Wet ponds shall generally be wedge-shaped with inflow at the narrow end to prevent short-circuiting and stagnation. However, other shapes meeting the design intent may be approved.
    - (c.) Permanent pools shall have a minimum depth of 3 feet across the deepest part of the basin to discourage aquatic plant infill and provide open water.
    - (d.) The design high water depth should generally not exceed 10 feet above the permanent pool elevation.
    - (e.) Where basins are to be maintained as a mown lawn to the water's edge, side slopes shall be no steeper than 4:1 (H:V) to facilitate mowing.
    - (f.) Near normal waterline – 7% maximum from 10.0" above to 24.0" below the normal waterline. Below this point, slopes must be no steeper than 1 vertical to 4 horizontal.  
NOTE: Permanent impoundments or open pit ponds designed as site amenities have an inherent risk, which must be assumed by the landowner. The landowner is the party responsible for policing his property. These types of site amenities will only be allowed if the district is held harmless by the landowner.
    - (g.) Warning signs prohibiting swimming and skating shall be posted for wet ponds.

## (4) Constructed Wetland

- (a.) The emergent vegetation zone shall comprise 60 to 65% of the total surface area. Half shall be high marsh with a normal water depth of 6 inches or less, and half shall be low marsh with a normal water depth between 6 and 18 inches.
- (b.) The open water zone shall comprise 35% to 40% of the total surface area with a normal water depth of between 18 inches and 6 feet.
- (c.) At a minimum, the volume of the permanent pool for the open water zone shall be 2.5 times the water quality volume to account for reduced settling efficiency due to turbulence caused by wind.
- (d.) The design high water surface elevation shall not exceed the normal water surface elevation by more than 4 feet.
- (e.) Side slopes shall be 4:1 to 5:1 (H:V).
- (f.) Safety benches shall be constructed on the slopes of constructed wetlands adjacent to a permanent pool 3 feet or deeper. Two benches shall be constructed, each a minimum of 4 feet in width at a maximum slope of 10%. The first bench shall be located 1 foot above the permanent pool level; the second bench shall be located 1 foot below the permanent pool level.
- (g.) A micro pool shall be located at the outlet of the stormwater wetland to protect the low flow pipe from clogging and prevent sediment resuspension. The micro pool shall be 3 to 6 feet deep and have a minimum surface area equivalent to the forebay.
- (h.) A pocket wetland shall consist of a forebay and micropool with safety benches.

## c. Inlet Design

- (1) Inlet pipes shall not be fully submerged at normal pool elevations.
- (2) Inlet pipes shall require energy dissipation. Riprap protection or equivalent erosion control measures shall be used where the velocity exceeds 4 feet per second up to maximum allowable design velocity of 8 feet per second.
- (3) Pretreatment is required for each inlet, unless the inlet supplies less than 10% of the total design flow to the detention basin.
- (4) Pretreatment shall be provided in a sediment forebay or spill containment cell located within the detention basin. For small sites, a water quality device located prior to the basin may be allowed. Pretreatment for overland sheet flow entering the basin can be provided through a vegetated filter strip.
- (5) When spill containment is required and a spill containment cell is used, all pipes contributing runoff from the high risk area must enter this cell for pretreatment.

## d. Outlet Design

- (1) The outlet shall consist of a multi-stage outlet and include a low flow orifice or multiple orifice openings, a primary overflow (typically provided through the top of a grated riser pipe), and a secondary emergency overflow spillway.

## (2) Low Flow Outlet

(a.) The low flow outlet may be designed using the orifice equation, rearranged to solve for area:

$$A = \frac{Q}{c \sqrt{2gH}} \quad (4.22)$$

where:

$A$  = required area (square feet)

$Q$  = required outflow (cubic feet per second)

$c$  = orifice coefficient (approximately 0.6)

$2g$  = 2 times the gravitation constant ( $g = 32.2$  feet per second)

$H$  = height of design high water level above center of orifice outlet (feet)

(b.) Other types of outlet devices shall have full design calculations provided for review.

(c.) The outlet shall be designed to prevent clogging.

(d.) Pipes or orifice plates shall have a minimum diameter of 4 inches.

(e.) Riser pipes with holes or slits shall be used to protect orifice openings less than 4 inches in diameter.

(f.) Orifices used to maintain a permanent pool shall be designed to withdraw water a minimum of 2 feet below the normal water surface.

## (3) Primary Overflow

(a.) All detention basins must have a primary overflow at the design high water level.

(b.) The primary overflow shall be designed to convey the 10-year peak inflow at the maximum design high water level. The depth of water at the crest of the secondary emergency overflow is the maximum design high water level.

(c.) The downstream outlet pipe shall be designed to convey the 10-year peak inflow from the primary overflow and the discharge from the low flow orifice at the maximum design high water level.

(d.) Hoods and trash racks shall be placed on riser pipes. Grate openings shall be a maximum of 3 inches on center. A vertical flow area must be provide where leaved and debris are prone to clog a horizontally seated grate.

(e.) Riser pipes shall have a minimum diameter of 24 inches. Riser pipes greater than 4 feet in height shall be a minimum of 48 inches in diameter.

(f.) Riser pipes shall be constructed of reinforced concrete or corrugated metal and be set in a concrete base designed to prevent buoyancy. Plastic is not acceptable as a riser material due to lack of durability.

(g.) The riser must be placed near or within the embankment to provide for ready maintenance access.

(h.) When possible, a drain for completely dewatering the detention basin shall be installed for maintenance purposes.

(i.) Pipes placed through embankments shall have anti-seep collars.

- (j.) Outlet pipes shall require energy dissipation. Riprap protection or equivalent erosion control measures shall be used where the velocity exceeds 4 feet per second up to maximum allowable design velocity of 8 feet per second.
- (4) Secondary Emergency Overflow
- (a.) All detention basins must have a provision for emergency overflow (i.e. a spillway).
- (b.) The spillway shall be designed for the 10-year peak inflow with a maximum flow depth of 1 foot. The spillway shall be sized using the weir equation:

$$Q = 2.6LH^{\frac{3}{2}} \quad (4.23)$$

where:

$Q$  = discharge (cubic feet per second)

2.6 = coefficient of discharge

$L$  = length of spillway crest (feet)

$H$  = total head measured above spillway crest (feet)

- (c.) Freeboard. The top of berm elevation shall be a minimum of 0.5 foot above the design flow depth over the spillway. In no case shall the spillway depth (distance between spillway crest and top of berm) be less than 1 foot.
- (d.) Overflow spillways shall be protected with concrete or turf reinforced with a three-dimensional root mat or geogrids, to prevent erosion of the structure. Protection shall extend across the entire spillway up to the top of berm, start on the basin side a minimum of 3 feet below the spillway crest and extend down the spillway to an apron a minimum of 6 feet beyond the toe of the spillway.
- e. Access
- (1) Outlet control structures shall be placed near or within the embankment to facilitate maintenance access.
- (2) Berm top width shall be a minimum of 12 feet.
- (3) A minimum 10-foot wide maintenance access route from a public or private right-of-way shall be provided to the basin. The access way shall have a vertical grade of no greater than 20% (5:1 H:V slope) and shall be stabilized to withstand the passage of heavy equipment. Direct access to the forebay, control structures and the outlet shall be provided.

4. Design Schematics

**DRY DETENTION BASIN**

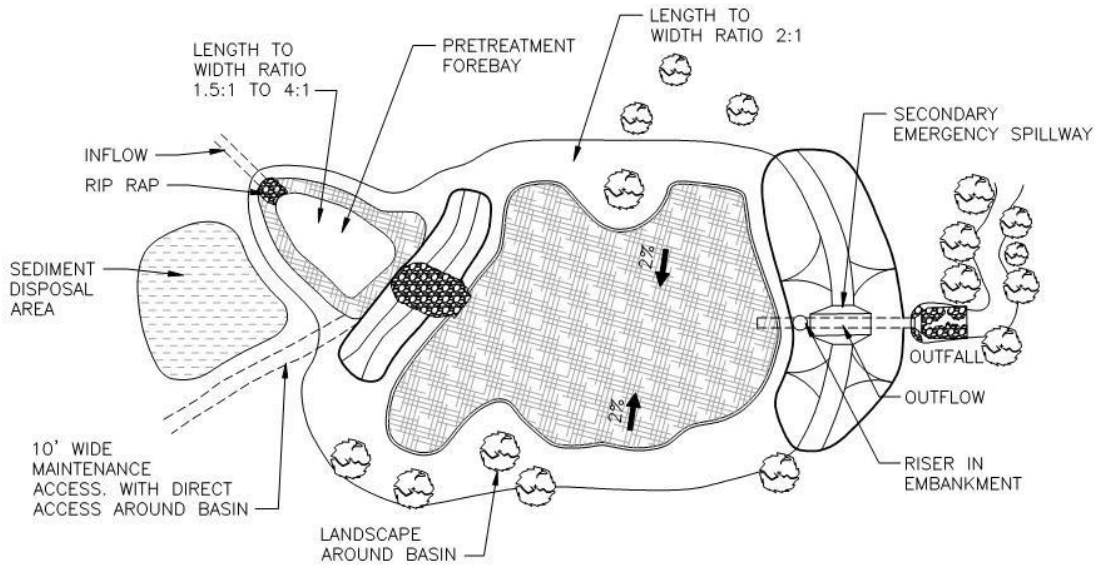

**PLAN VIEW**

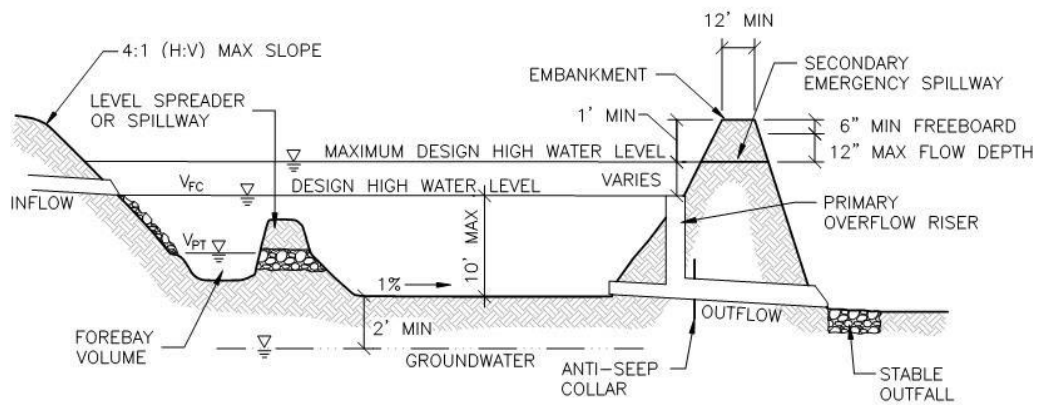

**PROFILE**

FINAL OUTLET CONFIGURATION MUST BE DESIGNED TO PREVENT CLOGGING

**EXTENDED DETENTION BASIN**

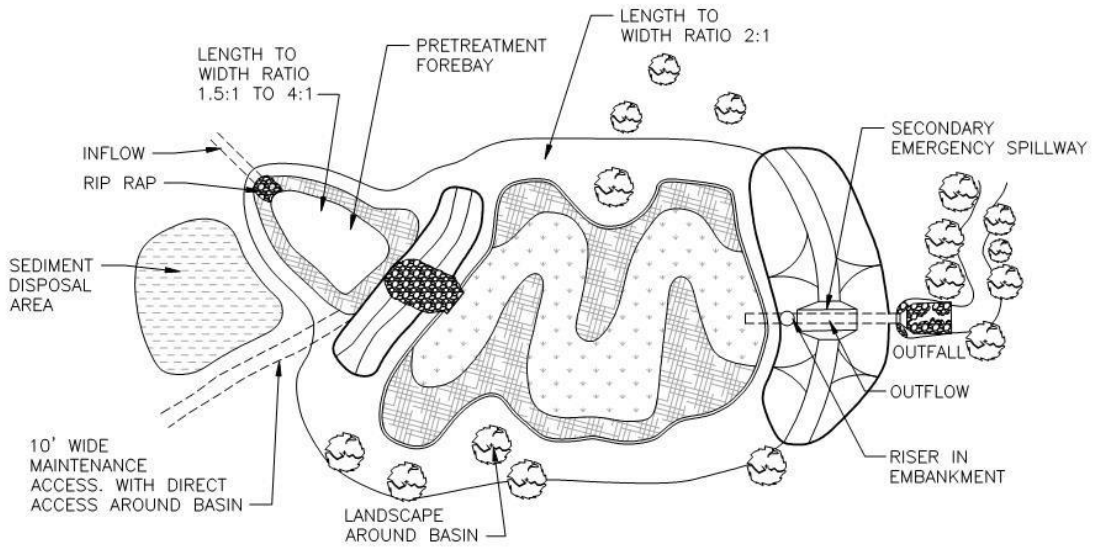

**PLAN VIEW**

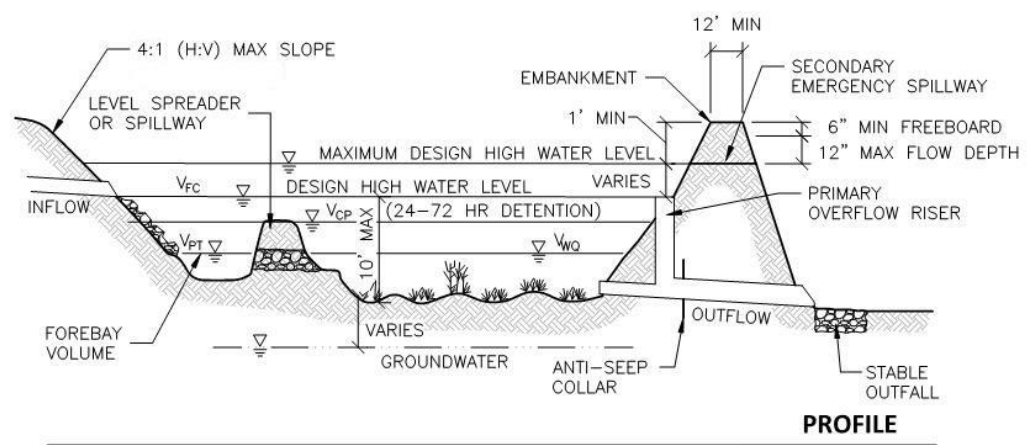

**PROFILE**

FINAL OUTLET CONFIGURATION MUST BE DESIGNED TO PREVENT CLOGGING



### WET DETENTION BASIN (WET POND)

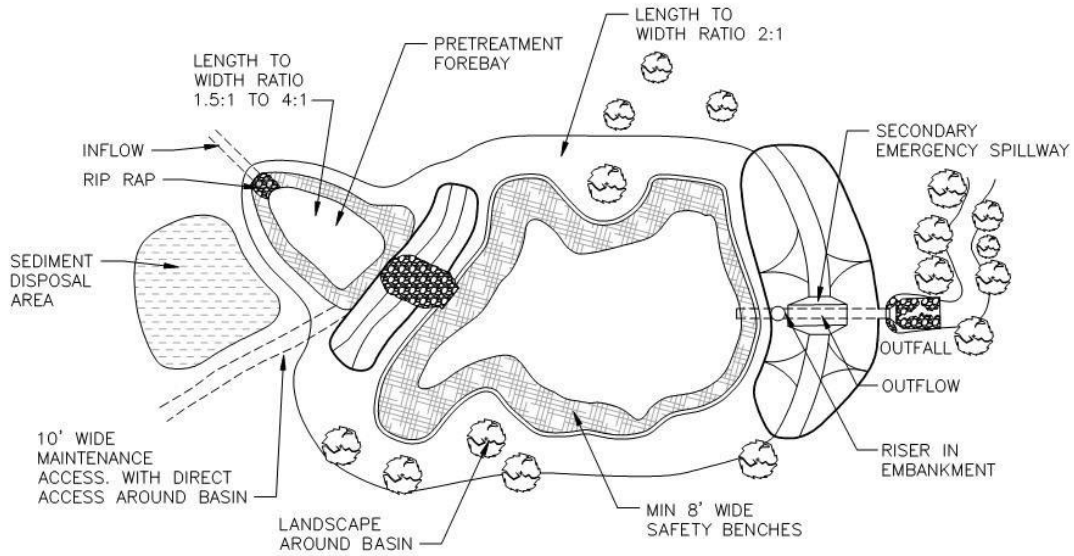

**PLAN VIEW**

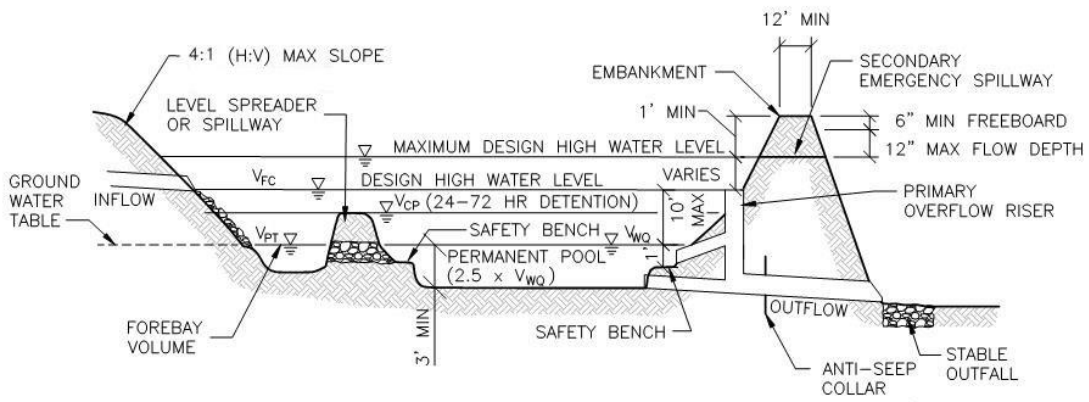

**PROFILE**

FINAL OUTLET CONFIGURATION MUST BE DESIGNED TO PREVENT CLOGGING

## CONSTRUCTED WETLAND

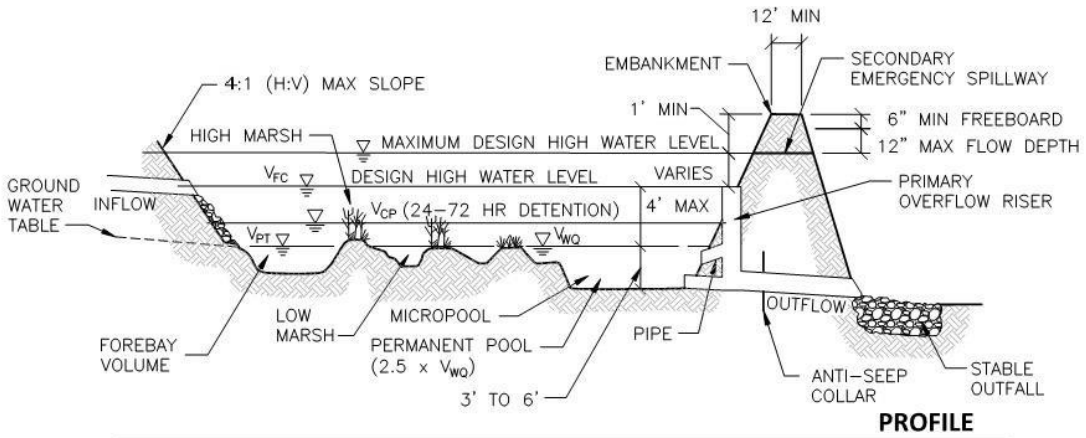
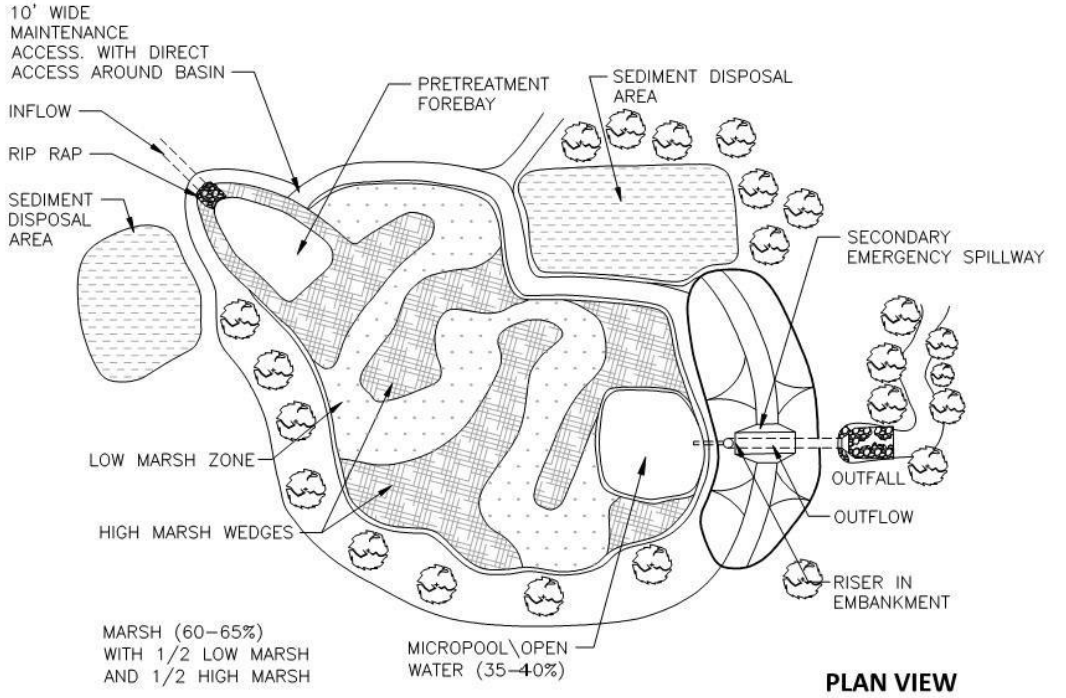

FINAL OUTLET CONFIGURATION MUST BE DESIGNED TO PREVENT CLOGGING

## E. Retention Basins

### 1. Summary

Description:	Provides stormwater storage without a surface outlet.
Application:	Practical for a wide range of applications including large sites. Not recommended for regional use without supplemental measures and provisions for a positive outlet.
Types:	Dry Basin; Wet Pond.
Pretreatment Required:	Yes.
Maintenance Plan:	Yes.
Calculation Credits:	
Volume Reduction:	Count volume stored and infiltrated.
Rate Reduction:	Designed for flood control: 100%.
Water Quality:	Count volume stored and infiltrated.

### 2. Sizing Calculations

- a. Calculate the required storage volume for flood control (refer to Part 4 section “Calculating Storage Volumes and Release Rates, Flood Control, Retention”).
- b. Calculate the minimum infiltration area required to drain the required storage volume in the specified drawdown time using the design infiltration rate of the underlying soil from field permeability tests or **Table 5**.

$$A = \frac{12V_s}{i(t_d)} \quad (4.24)$$

where:

- A = minimum infiltration area (square feet)
- V<sub>s</sub> = storage volume (cubic feet)
- i = design infiltration rate of soil (inches per hour)
- t<sub>d</sub> = maximum allowable drawdown time (hours)
- 12 = factor to convert inches to feet

- c. Drawdown time shall be no more than 72 hours.
- d. The infiltration area shall be defined as the bottom of the basin, or the horizontal projection of the side slopes up to half of the design water depth above a permanent pool.
- e. Where channel protection and water quality treatment are provided through upstream retention BMPs, these volumes may be subtracted from the total inflow volume. If provided in the same retention basin, channel protection and water quality volumes are included in the flood control volume.
- f. Size forebay(s) for pretreatment (refer to Part 4 section “Calculating Storage Volumes and Release Rates, Pretreatment”). Regional retention basins may require spill containment, additional pretreatment volume, or other measures to reduce the potential for groundwater contamination and protect the infiltration capacity of the BMP.
- g. Retention basins without an acceptable surface water overflow route shall be designed for 2 times the required flood control volume.

### 3. Design Requirements

- a. Siting
  - (1) Soil borings are required (refer to Part 4 section “Soils Investigation”).
    - (a.) A minimum of 3 feet is required between the bottom of dry retention basins and the highest known groundwater elevation.
  - (2) Setbacks shall be as follows:
    - (a.) Adjacent property line: 10 feet
    - (b.) Building foundation: 30 feet
    - (c.) Private well: 50 feet
    - (d.) Public well: 200 feet from Type I or Type IIa wells, 75 feet from Type IIb or Type III wells (Safe Drinking Water Act, Act 399, PA 1976)
    - (e.) Septic system drainfield: 100 feet
    - (f.) Airports: Per Federal Aviation Administration guidelines (wet ponds).
- b. Configuration
  - (1) General
    - (a.) Where steeper side slopes than those specified are unavoidable, safety railing, fencing or other access barriers may be approved.
  - (2) Dry Basin
    - (a.) The design high water depth should generally not exceed 7 feet above the bottom of the basin.
    - (b.) Side slopes shall not be steeper than 4:1 (H:V).
    - (c.) The bottom of dry retention basins shall be flat to encourage uniform ponding and infiltration.
    - (d.) The bottom of dry retention basins shall be scarified to a depth of 4 to 6 inches after final grading has been established.
    - (e.) Care must be taken during the excavation and finishing process to make sure that soil compaction does not occur.
  - (3) Wet Pond (no surface water outlet)
    - (a.) The design high water depth should generally not exceed 7 feet above the permanent pool elevation.
    - (b.) Where excavation and reshaping of the retention area is necessary, side slopes shall not be steeper than 4:1 (H:V).
    - (i.) Safety benches shall be constructed on the slopes of wet ponds with a permanent pool 3 feet or deeper. Two benches shall be constructed, each a minimum of 4 feet in width at a maximum slope of 10%. The first bench shall be located 1 foot above the permanent pool level; the second bench shall be located 1 foot below the permanent pool level.
    - (c.) Warning signs prohibiting swimming and skating shall be posted for wet ponds.

## c. Inlet Design

- (1) Inlet pipes shall not be fully submerged at normal pool elevations.
- (2) Inlet pipes shall require energy dissipation. Riprap protection or equivalent erosion control measures shall be used where the velocity exceeds 4 feet per second, up to maximum allowable design velocity of 8 feet per second.
- (3) Pretreatment is required for each inlet and shall be provided in a sediment forebay or spill containment cell located within the retention basin. For small sites, a water quality device may be allowed prior to the basin. Pretreatment for overland sheet flow entering the basin can be provided through a vegetated filter strip.
- (4) When spill containment is required and a spill containment cell is used, all pipes contributing runoff from the high risk area must enter this cell for pretreatment.

## d. Overflow

## (1) Primary Overflow

- (a.) When possible, retention basins must have a primary overflow at the design high water level.
- (b.) The primary overflow and downstream pipe shall be designed to convey the 10-year peak inflow at the maximum design high water level. The depth of water at the crest of the secondary emergency overflow is the maximum design high water level.
- (c.) Hoods and trash racks shall be placed on riser pipes. Grate openings shall be a maximum of 3 inches on center.
- (d.) Riser pipes shall have a minimum diameter of 24 inches. Riser pipes greater than 4 feet in height shall be a minimum of 48 inches in diameter.
- (e.) Riser pipes shall be constructed of reinforced concrete or corrugated metal and be set in a concrete base. Plastic is not acceptable as a riser material due to lack of durability.
- (f.) When possible, a drain for completely dewatering the retention basin shall be installed for maintenance purposes.
- (g.) Pipes placed through embankments shall have anti-seep collars.
- (h.) Outlet pipes shall require energy dissipation. Riprap protection or equivalent erosion control measures shall be used where the velocity exceeds 4 feet per second up to maximum allowable design velocity of 8 feet per second.

## (2) Secondary Emergency Overflow

- (a.) All retention basins must have a provision for emergency overflow (i.e. a spillway).
- (b.) The spillway shall be designed for the 10-year inflow with a maximum flow depth of 1 foot. The spillway shall be sized using the weir equation:

$$Q = 2.6LH^{\frac{3}{2}} \quad (4.23)$$

where:

- $Q$  = discharge (cubic feet per second)  
 $2.6$  = coefficient of discharge  
 $L$  = length of spillway crest (feet)  
 $H$  = total head measured above spillway crest (feet)

- (c.) Freeboard. The top of berm elevation shall be a minimum of 0.5 foot above the design flow depth over the spillway. In no case shall the spillway depth (distance between spillway crest and top of berm) be less than 1 foot.
  - (d.) Overflow spillways shall be protected with concrete, riprap or a permanent erosion control blanket (preferred) to prevent erosion of the structure. Protection shall extend across the entire spillway up to the top of berm, start on the basin side a minimum of 3 feet below the spillway crest and extend down the spillway to an apron a minimum of 6 feet beyond the toe of the spillway.
- e. Access
- (1) Berm top width shall be a minimum of 12 feet.
  - (2) A minimum 10-foot wide maintenance access route from a public or private right-of-way shall be provided to the basin. The access way shall have a vertical grade of no greater than 20% (5:1 H:V slope) and shall be stabilized to withstand the passage of heavy equipment. Direct access to the forebay, control structures and the outlet shall be provided.
- f. Supplemental Measures
- (1) Supplemental measures may be required to ensure that a retention basin drains sufficiently as the soil becomes less permeable with use. The need for supplemental measures may be based on a number of indicators including:
    - (a.) Soils with a design infiltration rate between 0.50 and 1.63 inches per hour (Sandy Loam).
    - (b.) High probability for sedimentation (particularly fines).
    - (c.) Larger regional basin where there is less control over contributing area runoff.
    - (d.) Probability of groundwater rising higher than minimum isolation distance.
  - (2) Supplemental measures may include:
    - (a.) Leaching basins or infiltration trench placed in the bottom of the basin.
    - (b.) Valved outlet to drain basin.
    - (c.) Conversion to a wet basin with sufficient storage volume provided above the permanent pool for reduced infiltration area.

4. Design Schematics

**DRY RETENTION BASIN**

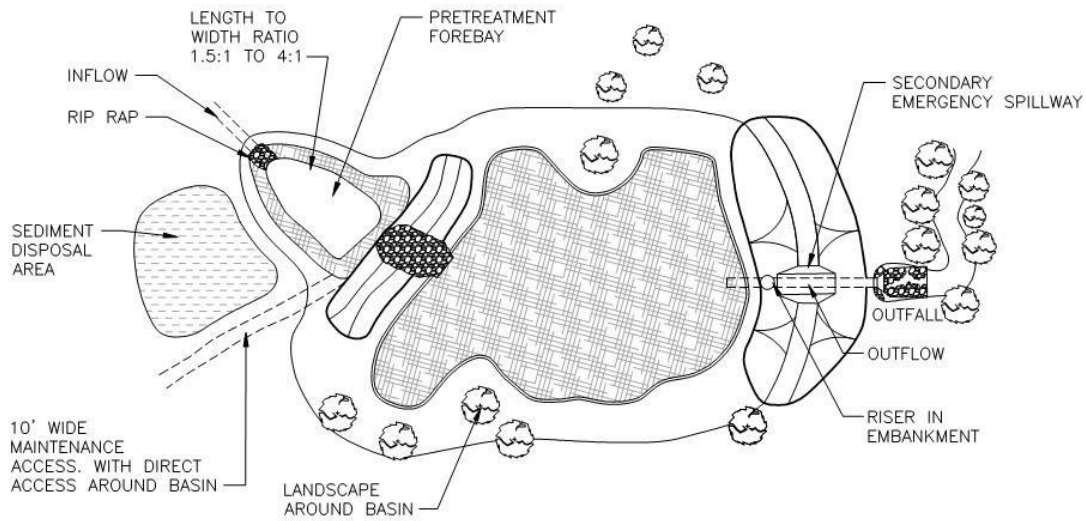

**PLAN VIEW**

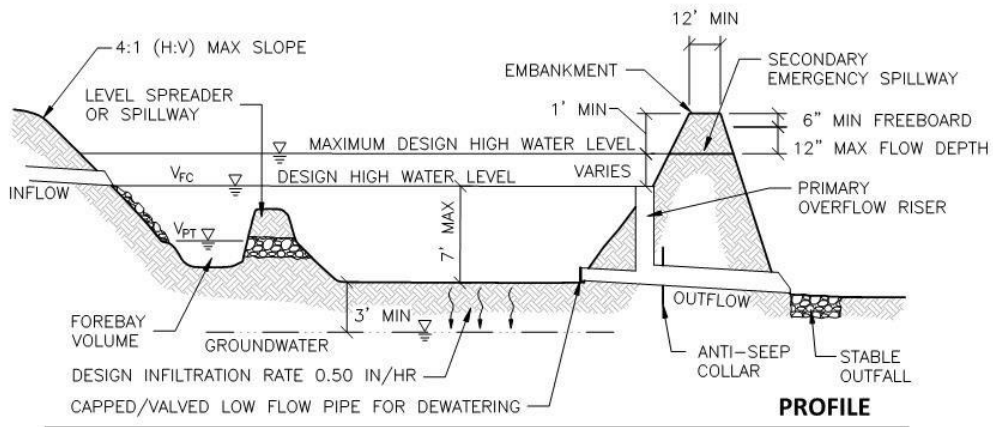

**PROFILE**

FINAL OUTLET CONFIGURATION MUST BE DESIGNED TO PREVENT CLOGGING

### WET RETENTION BASIN

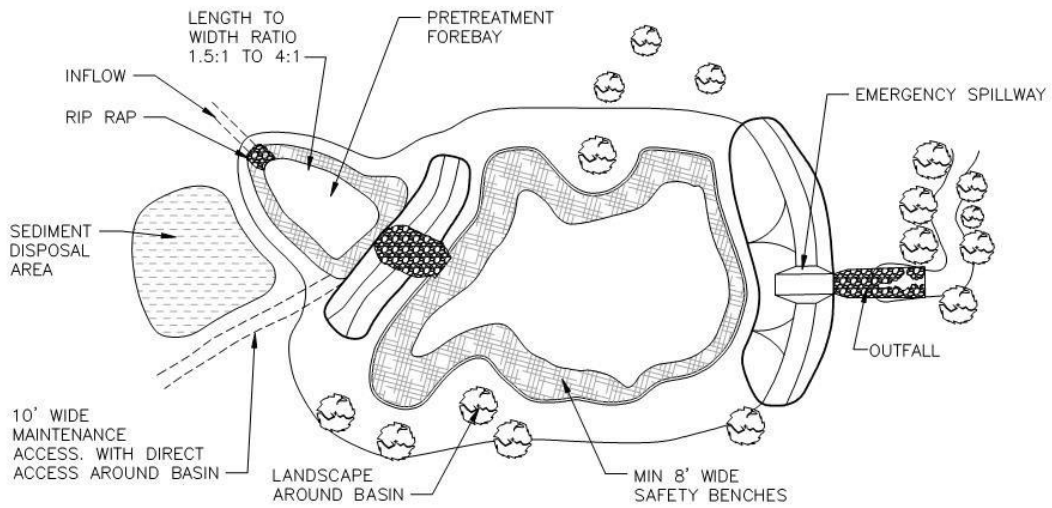

**PLAN VIEW**

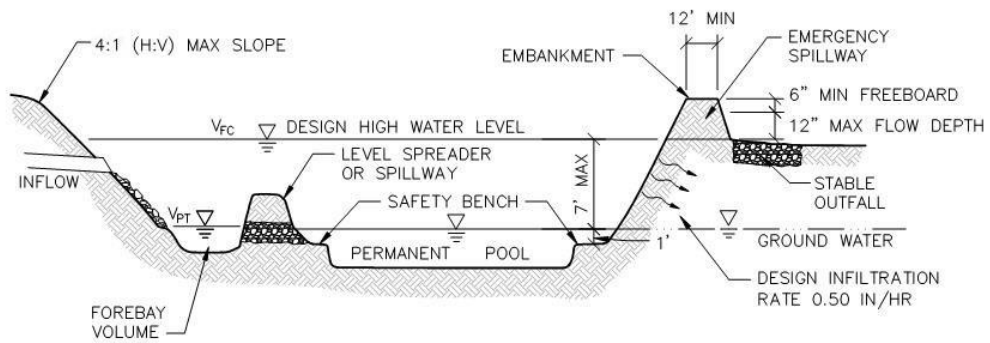

**PROFILE**



## F. Infiltration Practices

### 1. Summary

Description:	Stormwater treatment and storage without a surface outlet.
Application:	Practices are typically applicable to small sites and drainage areas.
Types:	Dry Well; Leaching Basin; Infiltration Trench; Infiltration Bed; Infiltration Berm.
Pretreatment Required:	Yes.
Maintenance Plan:	Yes.
Calculation Credits:	
Volume Reduction:	Count volume stored and infiltrated.
Rate Reduction:	Designed for flood control: 100%. Designed for channel protection and/or water quality: Adjust time-of-concentration by dividing storage volume by 10-year peak flow rate.
Water Quality:	Count volume stored and infiltrated.

### 2. Sizing Calculations

- Infiltration practices may be sized for channel protection or water quality treatment. Use the methods outlined in Part 4 section “Calculating Storage Volumes and Release Rates” to calculate the required volumes. Use the SEMCOG Method to calculate the required storage volume of the BMP.
- Infiltration practices may be able to provide flood control for small drainage areas. Use the formulas included in Part 4 section “Calculating Storage Volumes and Release Rates, Flood Control, Retention” to calculate the storage volume of the BMP.
- Calculate the minimum infiltration area required to drain the required storage volume in the specified drawdown time using the design infiltration rate of the underlying soil from field permeability tests or **Table 5**.

$$A = \frac{12V_s}{i(t_d)} \quad (4.24)$$

where:

- A = minimum infiltration area (square feet)
- V<sub>s</sub> = storage volume (cubic feet)
- i = design infiltration rate of soil (inches per hour)
- t<sub>d</sub> = maximum allowable drawdown time (hours)
- 12 = factor to convert inches to feet

- Total drawdown time shall be no more than 72 hours. Depth of surface ponding shall be no more than 2 feet and drain within 24 hours.

- e. Infiltration area shall be defined as:
- (1) Dry Well/Leaching Basin: Bottom and sides (lateral)
  - (2) Infiltration Trench: Bottom of trench (length x width) and ½ the height of each side
  - (3) Infiltration Bed: Bottom area of the bed
  - (4) Infiltration Berm: Ponding area (length of berm x average width of ponding behind berm)
- f. Calculate the storage volume of the BMP
- (1) Dry wells, infiltration trenches, infiltration beds:  

$$\text{Subsurface Storage Volume (cubic feet)} = \text{Length (feet)} \times \text{Width (feet)} \times \text{Depth (feet)} \times \text{Void Ratio of Material}$$

Where perforated pipe is used, the formula is modified:

$$\text{Subsurface Storage Volume (cubic feet)} = \text{Volume of Pipe (cubic feet)} + [\text{Length (feet)} \times \text{Width (feet)} \times \text{Depth (feet)} - \text{Volume of Pipe (cubic feet)}] \times \text{Void Ratio of Material}$$
  - (2) Leaching basins:  

$$\text{Storage Volume (cubic feet)} = \Pi r^2 \text{ (square feet)} \times \text{Depth (feet)}$$

where:  
r = radius of leaching basin (feet)  
 $\Pi = \pi$  (approximately 3.14)

Volume of storage in stone envelope around leaching basin may also be counted.
  - (3) Infiltration berm:  

$$\text{Surface Storage Volume (cubic feet)} = \text{Average Ponding Area (square feet)} \times \text{Design High Water Depth (feet)}$$

### 3. Design Requirements

- a. Siting
- (1) Soil borings are required (refer to Part 4 section “Soils Investigation”).
    - (a.) A minimum of 4 feet is required between the bottom of infiltration practices and the highest known groundwater elevation.
    - (b.) Void ratio for the imported material shall be based on the USDA soil textural class and effective water capacity in **Table 5**. A maximum design value of 0.40 shall be used for the void ratio of stone.
  - (2) Setbacks shall be as follows:
    - (a.) Adjacent property line: 10 feet
    - (b.) Building foundation: 10 feet
    - (c.) Private well: 50 feet
    - (d.) Public well: 200 feet from Type I or Type IIa wells, 75 feet from Type IIb or Type III wells (Safe Drinking Water Act, Act 399, PA 1976)
    - (e.) Septic system drainfield: 100 feet
  - (3) Infiltration practices shall be located outside of the drip line of adjacent trees to avoid root intrusion.

- b. Configuration
  - (1) General
    - (a.) A combination of surface and subsurface storage may be used to provide the required storage volume.
  - (2) Dry wells, infiltration trenches and infiltration beds
    - (a.) Infiltration trench width shall generally be as follows: 3-foot minimum to 6-foot maximum.
    - (b.) Coarse aggregates shall be uniformly graded, washed and wrapped in a non-woven geotextile to provide separation between the aggregate and the surrounding soil and prevent fines from clogging the infiltration surface.
    - (c.) An observation well shall be provided for each dry well, at each end of an infiltration trench, and at each corner of an infiltration bed with intermediate center wells added so as not to exceed maximum distance of 50 feet between wells.
    - (d.) Perforated pipes laid flat may be used to distribute runoff over the bottom of infiltration trenches and infiltration beds.
    - (e.) Cleanouts shall be provided at pipe ends.
    - (f.) Care must be taken during the excavation and finishing process to make sure that soil compaction does not occur.
  - (3) Leaching Basins
    - (a.) Leaching basins shall have a minimum diameter of 4 feet, and meet the layout requirements for catchbasins (refer to “Storm Sewer”).
    - (b.) Leaching basins shall have an open bottom and perforations around the circumference of the structure at no greater than 12-inch intervals horizontally and vertically the entire depth of the sump.
    - (c.) Bedding and backfill shall consist of clean stone with nonwoven geotextile fabric placed along the walls of the trench and wrapped around the stone and the basin.
  - (4) Infiltration Berms
    - (a.) Infiltration berms shall be constructed along (parallel to) contours at a constant level elevation.
    - (b.) Maximum berm height shall be 2 feet to prevent excessive ponding behind berm.
    - (c.) Berm top width shall be a minimum of 2 feet.
    - (d.) Side slopes shall not be steeper than 4:1 (H:V) to facilitate mowing and ensure stable side slopes.
    - (e.) Well compacted cohesive soil shall be used to construct the berm.
    - (f.) The berm shall be well vegetated to prevent erosion if overtopped.
- c. Inlet Design
  - (1) Pretreatment is required for each inlet and for overland flow entering the infiltration practice. Exceptions may be allowed for small paved drainage areas contributing directly to a leaching basin.
- d. Emergency Overflow
  - (1) All infiltration practices must have a provision for overflow at the high water level.
  - (2) Infiltration practices without an acceptable surface water overflow route shall be designed for 2 times the required flood control volume.
- e. Access
  - (1) Inspection and maintenance access to the infiltration practice shall be provided.

- (2) The Developer/Owner shall sign a maintenance agreement that requires that the retention basin be monitored for 3-years or until the last home site has been constructed and the lawn is established. The basin shall be inspected every two weeks or within 24 hours after a significant storm event during the growing season or while the soil in the basin is exposed. Any accumulation of sediment on the bottom of the basin shall be clean out and disk the soil in the bottom if necessary. A performance bond shall be submitted to ensure the work will be completed.

4. Design Schematics

**INFILTRATION PRACTICES**

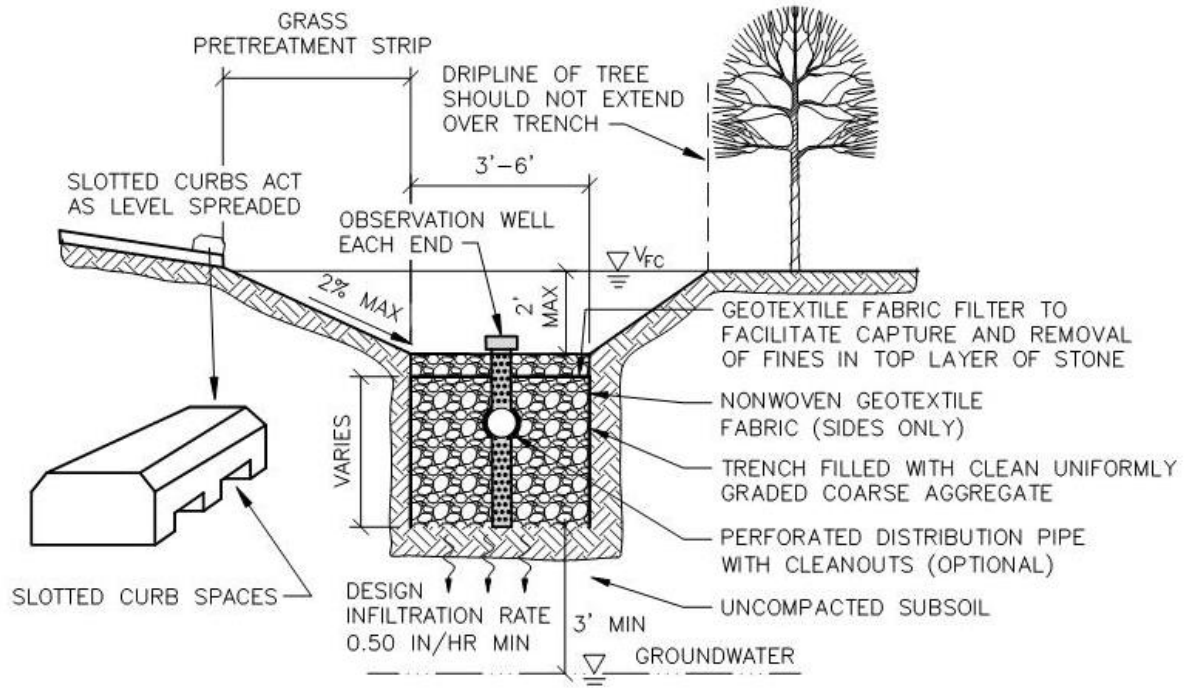

**INFILTRATION TRENCH**

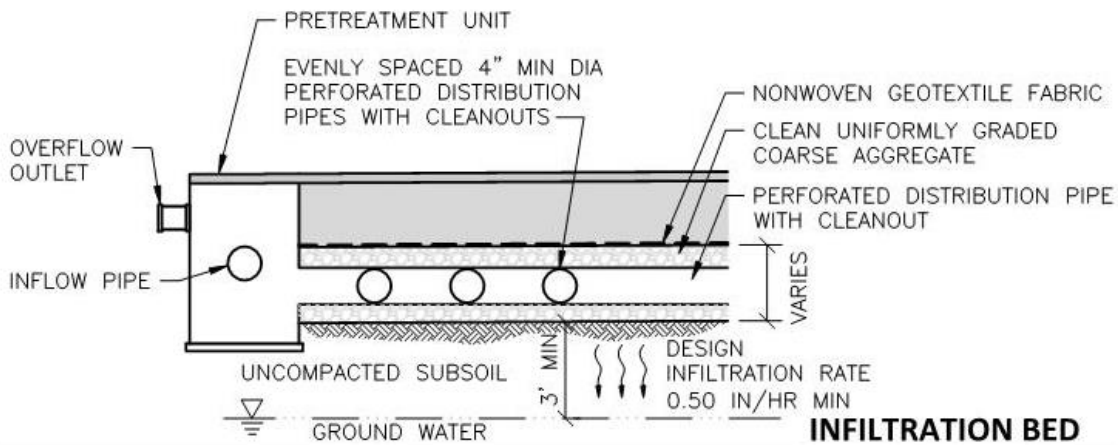

**INFILTRATION BED**

## INFILTRATION PRACTICES

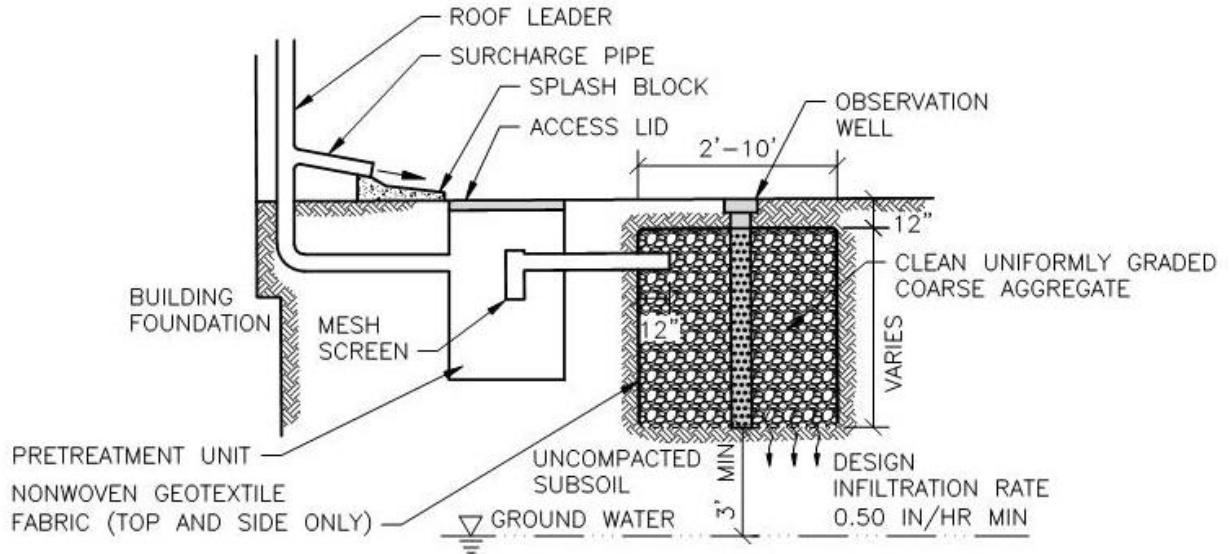

**DRY WELL**

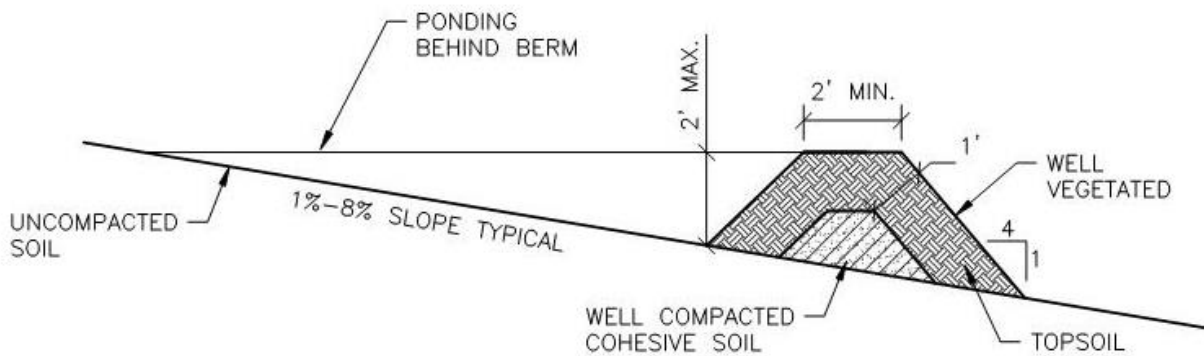

**INFILTRATION BERM**

## G. Bioretention/Rain Garden

### 1. Summary

Description:	Provides stormwater treatment, storage and uptake with or without a surface outlet.
Application:	Small sites and drainage areas. Underdrained BMP may be used on small sites to provide extended detention.
Types:	Bioretention: Natural-looking herbaceous. Rain garden: Landscaped and manicured. Infiltration; Underdrain at top of storage layer; Underdrain at bottom of storage layer; Lined.
Pretreatment Required:	Yes.
Maintenance Plan:	Yes.
Calculation Credits:	
Volume Reduction:	Infiltration: Count volume stored and infiltrated. Underdrained: Count volume stored and infiltrated between bottom of BMP and invert of underdrain.
Rate Reduction:	Adjust time-of-concentration by dividing storage volume by 10-year peak flow rate.
Water Quality:	Count volume stored and infiltrated, or routed through filter.

### 2. Sizing Calculations

- For underdrained BMP, follow criteria for “Constructed Filter.”
- Bioretention/rain gardens may be sized for channel protection or water quality treatment. Use the methods outlined in Part 4 section “Calculating Storage Volumes and Release Rates” to calculate the required volumes. Use the SEMCOG Method to calculate the required storage volume of the BMP.
- Bioretention/rain gardens may be able to provide flood control for small drainage areas. Use the formulas included in Part 4 section “Calculating Storage Volumes and Release Rates, Flood Control, Retention” to calculate the storage volume of the BMP.
- Minimum surface area (loading ratio): 0.06 times contributing impervious area, with a maximum impervious area of 1 acre (43,560 square feet) per bioretention cell.
- Calculate the minimum infiltration area required to drain the required storage volume in the specified drawdown time using the design infiltration rate of the underlying soil (from field permeability tests or **Table 5**), or the effective infiltration rate of the bioretention/rain garden soil mixture (from **Table 14**) if less. The bottom area of the BMP shall be used as the infiltration area.

$$A = \frac{12V_s}{i(t_d)} \quad (4.24)$$

where:

- A = minimum infiltration area (square feet)
- V<sub>s</sub> = storage volume (cubic feet)
- i = design infiltration rate of soil (inches per hour)
- t<sub>d</sub> = maximum allowable drawdown time (hours)
- 12 = factor to convert inches to feet

- f. Total drawdown time shall be no more than 72 hours. Depth of surface ponding shall be no more than 12 inches and drain within 12 hours. Surface ponding depth may be increased up to 24 inches for bioretention areas and drain within 24 hours.

- g. Calculate the storage volume of the BMP:

*Average Bed Area (square feet) = [Area at Design High Water Depth (square feet) + Bottom Area (square feet)] / 2*

*Surface Storage Volume (cubic feet) = Average Bed Area (square feet) x Design High Water Depth (feet)*

*Subsurface Storage Volume (cubic feet) = Length (feet) x Width (feet) x Depth (feet) x Void Ratio of Material*

*Total Storage Volume (cubic feet) = Surface Storage Volume (cubic feet) + Subsurface Storage Volume (cubic feet)*

### 3. Design Requirements

- a. Siting

- (1) Soil borings are required (refer to Part 4 section “Soils Investigation”).
  - (a.) A minimum of 3 feet is required between the bottom of bioretention/rain gardens capable of infiltration and the highest known groundwater elevation.
  - (b.) A minimum of 2 feet is required between the bottom of lined or underdrained bioretention/rain gardens and the highest known groundwater elevation.
  - (c.) An underdrain shall be provided for design infiltration rates of the underlying native soil less than 0.50 inches per hour, or if bioretention/rain garden will be lined.
  - (d.) Void ratio for the amended soil material shall be based on the USDA soil textural class and effective water capacity in **Table 5**. A maximum design value of 0.30 shall be used for the void ratio of the amended soil material. A maximum design value of 0.40 shall be used for the void ratio of stone.
- (2) Setbacks shall be as follows:
  - (a.) Adjacent property line: 10 feet
  - (b.) Building foundation: 10 feet
  - (c.) Private well: 50 feet
  - (d.) Public well: 200 feet from Type I or Type IIa wells, 75 feet from Type IIb or Type III wells (Safe Drinking Water Act, Act 399, PA 1976)
  - (e.) Septic system drainfield: 100 feet

- b. Configuration

- (1) General
  - (a.) The bottom shall be flat to encourage uniform ponding and infiltration.
  - (b.) Minimum bottom width shall be 3 feet.
  - (c.) Bioretention/rain gardens located in areas with steep slopes shall be terraced to minimize earth disturbance and maximize infiltration area.
  - (d.) Care must be taken during the excavation and finishing process to make sure that soil compaction does not occur.
  - (e.) Bioretention/rain gardens located in areas of existing soil contamination shall be lined to prevent infiltration.



- (f.) Underdrains shall have a 4-inch minimum pipe diameter.
  - (g.) All underground pipes shall have clean-outs accessible from the surface.
  - (h.) Pipes shall be sloped to prevent siltation.
  - (i.) Side slopes shall not be steeper than 4:1 (H:V), unless landscape retaining walls are used.
  - (j.) An observation well shall be provided for each bioretention/rain garden without a bottom underdrain.
- (2) Rain gardens
- (a.) A landscape plan shall be provided.
- c. Inlet Design
- (1) Inlet pipes shall require energy dissipation. Riprap protection or equivalent erosion control measures shall be used where the velocity exceeds 4 feet per second up to a maximum allowable design velocity of 8 feet per second.
  - (2) Pretreatment is required for each inlet and for overland flow entering the bioretention/rain garden.
- d. Emergency Overflow
- (1) All bioretention/rain gardens must have a provision for overflow at the high water level.
- e. Materials
- (1) Amended soil material shall consist of 18 to 48 inches of the following materials, evenly mixed: Compost: minimum 20%; Sand: 20-80%; Topsoil: maximum 30% (with less than 10% clay content).
    - (a.) Alternative mix designs with ratios outside of the limits provided will be considered with justification.
    - (b.) The soil mix shall have a pH between 5.5 and 7.5.
  - (2) Stone shall consist of clean, uniformly graded coarse aggregate.
  - (3) A woven geotextile fabric shall be placed between the amended soil and the stone, when a stone layer is used.
  - (4) When used, impermeable liner shall have a maximum permeability of  $1 \times 10^{-7}$  centimeters per second certified by the manufacturer.
  - (5) Plant selection shall consider exposure and tolerance to salt, sediment and pollutants, and the design depth of surface storage. Native species are encouraged.
    - (a.) Bioretention: Plugs and seed.
    - (b.) Rain gardens: Container stock.
  - (6) Mulch shall be applied after planting.
    - (a.) Bioretention: Straw mulch or mulch blanket shall be uniformly applied and tacked.
    - (b.) Rain gardens: Shredded hardwood mulch shall be uniformly applied to a depth of 2 to 3 inches.
- f. Access
- (1) Inspection and maintenance access to the bioretention/rain garden shall be provided.

4. Design Schematics

**BIORETENTION/RAIN GARDEN**

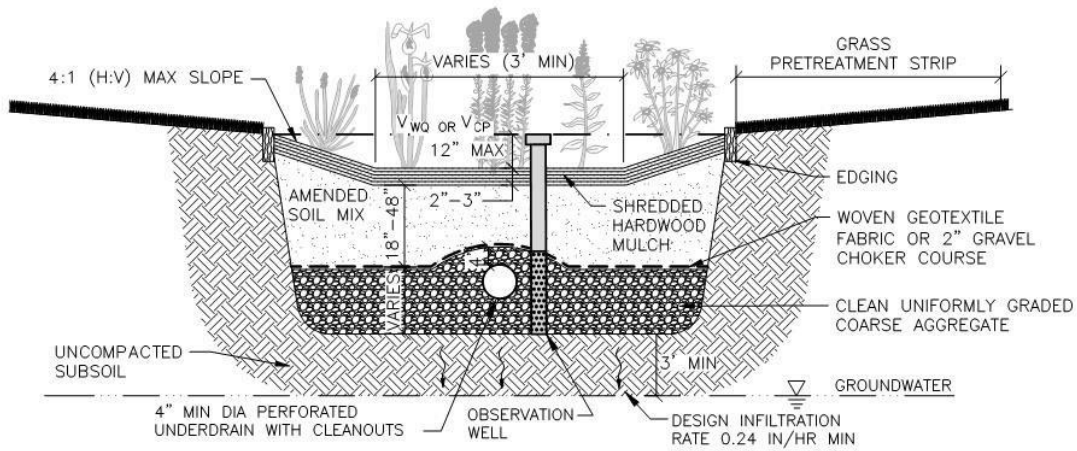
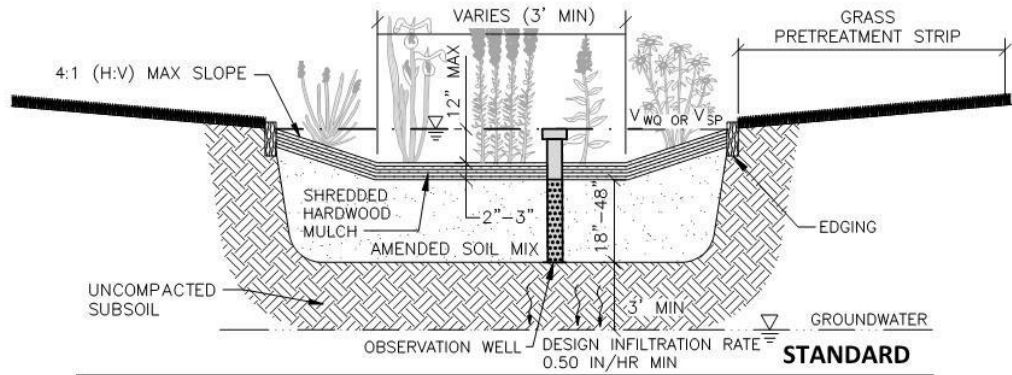

**BIORETENTION/RAIN GARDEN WITH STONE STORAGE LAYER**

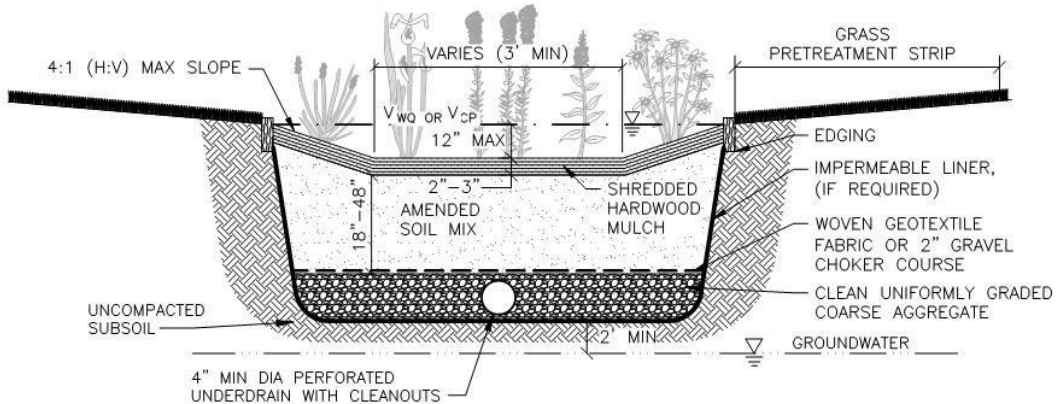

**BIORETENTION/RAIN GARDEN WITH BOTTOM DRAIN**

## H. Constructed Filter

### 1. Summary

Description:	Provides stormwater treatment and storage with a surface outlet (underdrain).
Application:	Areas with high heavy metal pollutant loads. May be used on small sites to provide extended detention.
Types:	Sand; Gravel; Sand/compost mix; Other media. Dry; Static water level within filter media.
Pretreatment Required:	Yes.
Maintenance Plan:	Yes.
Calculation Credits:	
Volume Reduction:	None.
Rate Reduction:	Adjust time-of-concentration by dividing storage volume by 10-year peak flow rate.
Water Quality:	Count volume routed through filter.

### 2. Sizing Calculations

- Use the methods outlined in Part 4 section “Calculating Storage Volumes and Release Rates” to calculate the required volumes for channel protection, water quality and/or pretreatment.
- Calculate filter surface area required to drain the design volume in the specified drawdown time using hydraulic conductivity of filter media:

$$A = \frac{V(d_f)}{K(t_d)(h_f + d_f)} \quad (4.25)$$

where:

- A = minimum surface area of filter (square feet)
- V = design runoff volume (cubic feet)
- $d_f$  = depth of filter media (1.5-foot minimum to 3-foot maximum)
- K = hydraulic conductivity (feet per day)
- $t_d$  = maximum allowable drawdown time (days)
- $h_f$  = average head; typically ½ of the maximum head on filter media (feet)

- Total drawdown time shall be no more than 72 hours. Maximum depth of surface ponding above the filter bed shall be 24 inches and drain within 24 hours.
- Check whether soil conductivity or hydraulics of underdrain governs.

### 3. Design Requirements

- Siting
  - Soil borings are required (refer to Part 4 section “Soils Investigation”).
    - A minimum of 2 foot is required between the bottom of the constructed filter and the highest known groundwater elevation.
    - Design values for hydraulic conductivity of the filter media shall be as specified in **Table 14**. Values for other types of filter media will be reviewed for use on an individual basis.

**Table 14 –Hydraulic Conductivities for Filter Media**

Filter Media	Hydraulic Conductivity, K (feet per day)
Gravel	14 <sup>1</sup>
Compost (loose)	8.7 <sup>2</sup>
Coarse Sand	3.5 <sup>2</sup>
Peat	2 <sup>2</sup>
Topsoil (< 10% clay)	1.3 <sup>3</sup>
<sup>1</sup> Adapted from William E. Sanford, et. al. (1995). <i>Hydraulic Conductivity of Gravel and Sand as Substrates in Rock-reed Filters</i> , Table 3 (using lowest initial conductivity for sand and gravel (0.25 cm/s) and correction factors from Source 2 (p. 5-18) to obtain a design value). <sup>2</sup> Center for Watershed Protection (1996). <i>Design of Stormwater Filtering Systems</i> . <sup>3</sup> D. Carpenter and L. Hallam (2007). <i>An Investigation of Rain Garden Planting Mixtures and the Implications for Design</i> .  A composite value of hydraulic conductivity for mixture combinations shall be calculated as: $K = (\% \times K1 + \% \times K2 + \% \times K3) / 100$  Effective infiltration rate, $i$ (in/hr) = $\frac{K(h_f + d_f)}{2d_f}$ where variables are as defined in Equation 4.25.	

## b. Configuration

- (1) Filter media shall have a minimum depth of 18-inches and a maximum depth of 36 inches.
- (2) Stone bedding shall consist of at least 2 inches under the pipe and 4 inches above the pipe. An aggregate window extending to the filter surface may also be provided as a factor-of-safety.
- (3) A 4-inch minimum diameter underdrain shall be provided in the gravel layer with lateral spacing at 10 feet, and in any case no more than 25 feet.
- (4) All underground pipes shall have clean-outs accessible from the surface.
- (5) Pipes shall be sloped to prevent siltation.
- (6) Constructed filters located in areas of existing soil contamination shall be lined to prevent infiltration.

## c. Inlet Design

- (1) A level spreader, distribution pipes or other flow dispersion measure shall be used for energy dissipation and to uniformly distribute the flow.
- (2) Pretreatment is required for each inlet and for overland flow entering the constructed filter.

## d. Emergency Overflow

- (1) All constructed filters must be designed so that larger storms may safely overflow or bypass the filter. Flow splitters, multi-stage chambers or other devices may be used.
- (2) Sufficient space must be provided between the top of the filtering bed and the overflow to allow the maximum design head to be stored for filtration.

## e. Materials

- (1) Stone bedding shall consist of clean, uniformly graded coarse aggregate (MDOT coarse or open-graded aggregate).
- (2) A woven geotextile fabric, or an additional 2 inches of gravel choker course shall be placed between the filter media layer(s) and the stone layer.
- (3) When used, impermeable liner shall have a maximum permeability of  $1 \times 10^{-7}$  centimeters per second certified by the manufacturer.

## f. Access

- (1) Inspection and maintenance access to the constructed filter shall be provided.
- (2) For underground vault heights greater than 4 feet, ladder access shall be provided.

## 4. Design Schematics

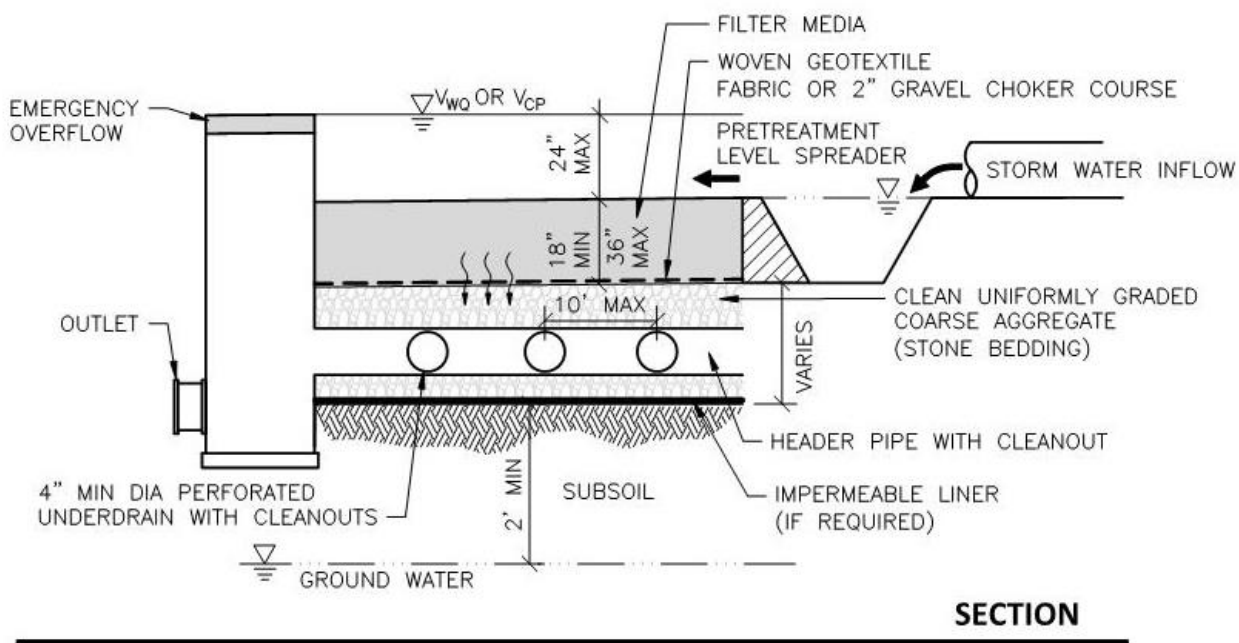
**CONSTRUCTED FILTER**

## I. Planter Box

### 1. Summary

Description:	A type of rain garden.
Application:	Small sites or highly urban areas. Underdrained BMP may be used on small sites to provide extended detention.
Types:	Infiltration; Underdrain at top of storage layer; Underdrain at bottom of storage layer; Lined.
Pretreatment Required:	No.
Maintenance Plan:	Yes.
Calculation Credits:	
Volume Reduction:	Infiltration: Count volume stored and infiltrated. Underdrained: Count volume stored and infiltrated between bottom of BMP and invert of underdrain.
Rate Reduction:	Adjust time-of-concentration by dividing storage volume by 10-year peak flow rate.
Water Quality:	Count volume stored and infiltrated, or routed through filter.

### 2. Sizing Calculations

- For underdrained BMP, follow criteria for “Constructed Filter.”
- Planter boxes may be sized for channel protection or water quality treatment. Use the methods outlined in Part 4 section “Calculating Storage Volumes and Release Rates” to calculate the required volumes. Use the SEMCOG Method to calculate the required storage volume of the BMP.
- Minimum surface area (loading ratio): 0.06 times contributing impervious area, with a maximum impervious area of 15,000 square feet per planter box.
- Calculate the minimum infiltration area required to drain the required storage volume in the specified drawdown time using the design infiltration rate of the underlying soil (from field permeability testing or **Table 5**), or the effective infiltration rate of the planter box soil mixture (from **Table 14**) if less.

$$A = \frac{12V_s}{i(t_d)} \quad (4.24)$$

where:

- A = minimum infiltration area (square feet)
- V<sub>s</sub> = storage volume (cubic feet)
- i = design infiltration rate of soil (inches per hour)
- t<sub>d</sub> = maximum allowable drawdown time (hours)
- 12 = factor to convert inches to feet

- Total drawdown time shall be no more than 12 hours. Depth of surface ponding shall be no more than 12 inches and drain within 4 hours.
- The bottom area of the BMP shall be used as the infiltration area.

- g. Calculate the storage volume of the BMP:

*Surface Storage Volume (cubic feet) = Bed Area (square feet) x Design High Water Depth (feet)*

*Subsurface Storage Volume (cubic feet) = Length (feet) x Width (feet) x Depth (feet) x Void Ratio of Material*

*Total Storage Volume (cubic feet) = Surface Storage Volume (cubic feet) + Subsurface Storage Volume (cubic feet)*

### 3. Design Requirements

- a. Siting

- (1) Soil borings are required (refer to Part 4 section “Soils Investigation”).

(a.) A minimum of 3 feet is required between the bottom of the planter box and the highest known groundwater elevation.

(b.) A minimum of 2 foot is required between the bottom of a lined or underdrained planter box and the highest known groundwater elevation.

(c.) An underdrain shall be provided for design infiltration rates less than 0.50 inches per hour, or if planter box will be lined.

(d.) Void ratio for the amended soil material shall be based on the USDA soil textural class and effective water capacity in **Table 5**. A maximum design value of 0.30 shall be used for the void ratio of the amended soil material. A maximum design value of 0.40 shall be used for the void ratio of stone.

- b. Configuration

- (1) A combination of surface and subsurface storage may be used to provide the required storage volume.

- (2) Minimum width of planter boxes shall be 30 inches, or 18 inches if flow-through.

- (3) Care must be taken during the excavation and finishing process to make sure that soil compaction does not occur.

- (4) Planter boxes located in areas of existing soil contamination shall be lined to prevent infiltration.

- (5) Underdrains shall have a 4-inch minimum pipe diameter.

- (6) All underground pipes shall have clean-outs accessible from the surface.

- (7) Pipes shall be sloped to prevent siltation.

- (8) A planting plan shall be provided.

- c. Inlet Design

- (1) Inlet pipes shall require energy dissipation. Riprap protection or equivalent erosion control measures shall be used where the velocity exceeds 4 feet per second, up to a maximum allowable design velocity of 8 feet per second.

- d. Emergency Overflow

- (1) All planter boxes must have a provision for overflow at the high water level.

e. Materials

- (1) Suggested structural elements of planter boxes are stone, concrete, brick or pressure-treated wood.
- (2) Amended soil material shall consist of 12 to 36 inches of the following materials, evenly mixed: Compost: minimum 20%; Sand: 20-80%; Topsoil: maximum 30% (with less than 10% clay content).
  - (a.) Alternative mix designs with ratios outside of the limits provided will be considered with justification.
  - (b.) The soil mix shall have a pH between 5.5 and 6.5.
- (3) Stone bedding shall consist of clean, uniformly graded coarse aggregate.
- (4) A woven geotextile fabric shall be placed between the amended soil and the stone.
- (5) Impermeable liner shall have a maximum permeability of  $1 \times 10^{-7}$  centimeters per second certified by the manufacturer.
- (6) Plant selection shall consider exposure and tolerance to salt, sediment and pollutants, and the design depth of surface storage. Native species are encouraged.
- (7) Plants shall be container stock.

f. Access. Inspection and maintenance access to the planter box shall be provided.

4. Design Schematics

**PLANTER BOX**

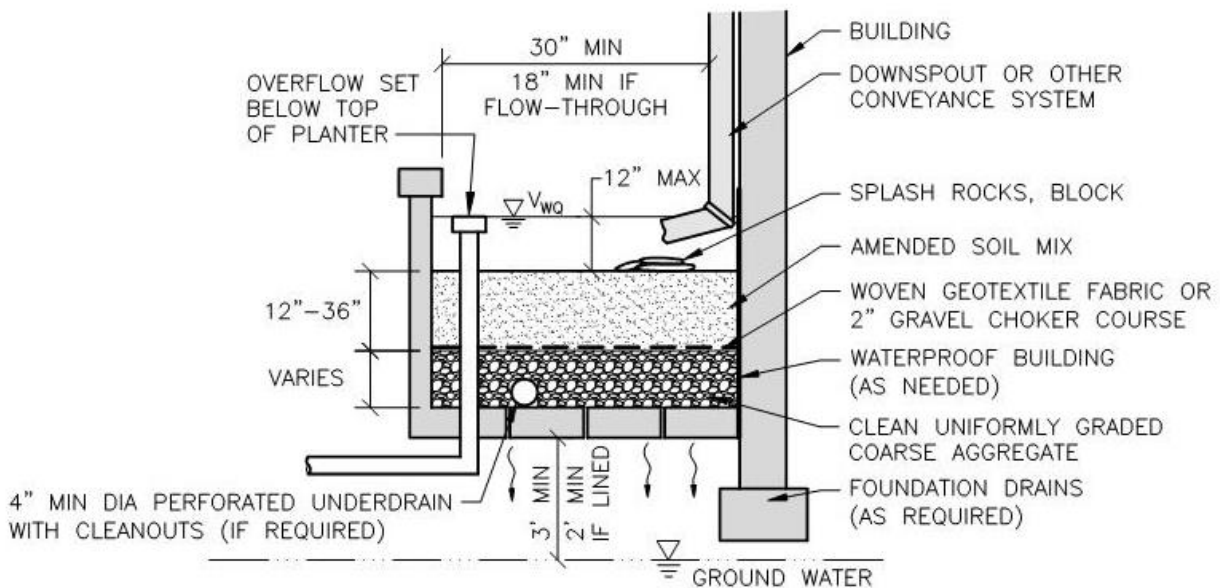

PLANTER MAY HAVE AN OPEN BOTTOM OR BE LINED

**SECTION**



## J. Pervious Pavement

### 1. Summary

Description:	Provides stormwater treatment and storage with or without a surface outlet.
Application:	Parking lots, alleys and roads and drives with low-volume vehicular traffic and minimal turning motions.
Types:	Infiltration; Underdrain at top of storage layer; Underdrain at bottom of storage layer; Lined.
Pretreatment Required:	No.
Maintenance Plan:	Yes.
Calculation Credits:	
Volume Reduction:	Infiltration: Count volume stored and infiltrated (limited by design rainfall on pavement and roof). Underdrained: Count volume stored and volume infiltrated between bottom of BMP and invert of underdrain (limited by design rainfall on pavement and roof).
Rate Reduction:	Infiltration: 100%. Underdrained: Calculated allowable release rate.
Water Quality:	Count volume stored and infiltrated, or volume filtered.

### 2. Sizing Calculations

- Use the methods outlined in Part 4 section “Calculating Storage Volumes and Release Rates” to calculate the required volumes for water quality and channel protection.
- The required storage volume shall be equal to the runoff volume from the contributing surface area (pavement, roof) for the design flood control event.
- The bottom area of the BMP shall be used as the infiltration area.
- Maximum allowable drawdown time shall be 72 hours.
- Calculate the subsurface storage volume of the BMP:

$$\text{Subsurface Storage Volume (cubic feet)} = \text{Length (feet)} \times \text{Width (feet)} \times \text{Depth (feet)} \times \text{Void Ratio of Material}$$

- For underdrained BMP, follow criteria for “Constructed Filter.”

### 3. Design Requirements

- Siting
  - Soil borings are required (refer to Part 4 section “Soils Investigation”).
    - A minimum of 3 feet is required between the bottom of pervious pavement capable of infiltration and the highest known groundwater elevation.
    - A minimum of 2 foot is required between the bottom of lined or underdrained pervious pavement and the highest known groundwater elevation.
    - An underdrain shall be provided for design infiltration rates less than 0.50 inches per hour, or if stone bed will be lined.
    - A maximum design value of 0.40 shall be used for the void ratio of stone.

- (2) Runoff from offsite areas shall not be directed onto pervious pavement surface.
- b. Configuration
  - (1) The stone bed shall be flat to encourage uniform ponding and infiltration.
  - (2) For pervious pavements located in areas with steep slopes, stone beds shall be terraced to maximize infiltration area.
  - (3) Pervious pavements located in areas of existing soil contamination shall be lined to prevent infiltration.
  - (4) Underdrains shall have a 4-inch minimum pipe diameter with lateral spacing at 10 feet, and in any case no more than 25 feet.
  - (5) All underground pipes shall have clean-outs accessible from the surface.
  - (6) Pipes shall be sloped to prevent siltation.
- c. Inlet Design
  - (1) Pervious pavements shall have a backup method for water to enter the storage bed. Backup drainage may consist of an unpaved 1- to 2-foot wide stone edge or inlets with sediment traps.
- d. Emergency Overflow
  - (1) Stone beds must have a provision for overflow below the level of the pavement surface when an underdrain is not already provided.
- e. Materials
  - (1) Stone bed shall consist of 8 to 36 inches of clean, uniformly graded coarse aggregate.
  - (2) A woven geotextile fabric or 2-inch gravel choker course shall be placed between the pervious pavement and stone bed.
  - (3) A nonwoven geotextile fabric or liner shall be placed between the stone bed and the subsoil for underdrained pavements.
  - (4) Impermeable liner shall have a maximum permeability of  $1 \times 10^{-7}$  centimeters per second certified by the manufacturer.

4. Design Schematics

**PERVIOUS PAVEMENT**

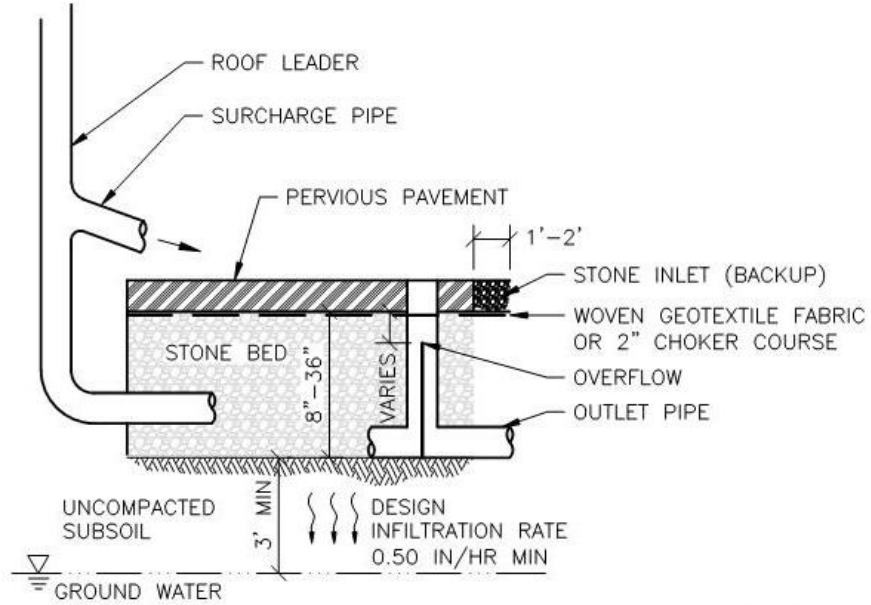

**STANDARD**

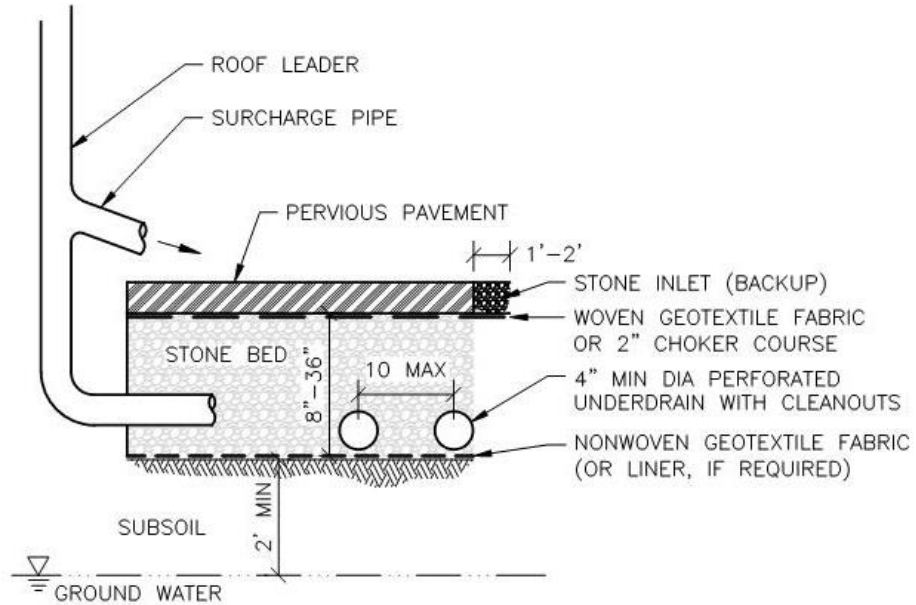

**PERVIOUS PAVEMENT WITH BOTTOM DRAIN**

## K. Capture Reuse

### 1. Summary

Description:	Stormwater capture, storage and removal from storm flow by reuse for irrigation or as greywater.
Application:	Most practical for roof runoff. Other collection areas may require pumping for reuse.
Types:	Rain barrels; Cisterns (both above ground and underground); Tanks; Ponds.
Pretreatment Required:	Yes. This BMP can provide spill containment.
Maintenance Plan:	Yes.
Calculation Credits:	
Volume Reduction:	Count storage volume provided.
Rate Reduction:	Adjust time-of-concentration by dividing storage volume by 10-year peak inflow rate.
Water Quality:	Count volume stored.

### 2. Sizing Calculations

- Determine water use (gallons per day) and add up for each month of the year.
- Obtain average monthly precipitation (inches) and evapotranspiration (ET) in inches.  
[www.enviroweather.msu.edu](http://www.enviroweather.msu.edu)
- Multiply average monthly precipitation by contributing area and area-weighted Small Storm Hydrology Method runoff coefficient (assuming 90% of the storms produce 1 inch of rain or less) to obtain volume of recharge. A modified equation for the Small Storm Hydrology Method is given below:

$$V = PR_v A(3630) \quad (4.26)$$

where:

$V$  = recharge volume (cubic feet)

$P$  = rainfall (inches)

$R_v$  = area-weighted volumetric runoff coefficient (individual runoff coefficients are given in **Table 9**)

$A$  = contributing area (acres)

$3630$  = factor to convert acre-inches to cubic feet

- Multiply recharge volume by 7.48 gallons per cubic foot to convert to gallons.
- Calculate ET for open water surfaces. Multiply average monthly ET (inches) by surface area of pond (square feet) and divide by 12 to calculate the volume of water evaporated in cubic feet. Multiply by 7.48 gallons per cubic foot to convert to gallons.
- Select trial size container or pond volume.
- Calculate the water balance. A tabular method may be used similar to that illustrated below.
- Adjust size of container or pond to balance reuse efficiency and cost.

*Volume of Water in Storage at End of Month = Storage Volume at Start of Month + Recharge from Monthly Precipitation – ET – Monthly Water Use*

Month	Vstart	+Recharge	-Et	-Use	=Vend*	Lost
1						
2	=Vend1					
Total	--				--	

\*Limited by total volume of the selected container or pond. If value is greater than container volume, surplus is lost to overflow. If value is negative, it means that amount must be supplemented.

### 3. Design Requirements

#### a. Siting

- (1) Storage units shall be positioned to receive rooftop runoff.
- (2) Protect storage units from direct sunlight to minimize algae growth.
- (3) Discharge points and storage units shall be clearly marked "Caution: Untreated Rainwater. Do Not Drink."

#### b. Configuration

- (1) If storage units are used to supplement greywater needs, a parallel conveyance system must be installed to separate greywater from other potable water piping systems.
- (2) Storage units shall be watertight with a smooth interior surface.
- (3) Covers and lids shall have a tight fit to keep out surface water, insects, animals, dust and light.
- (4) Observation risers shall be provided for buried storage units.
- (5) Pumps and pressure tanks may be used to add pressure (most irrigation systems require at least 15 pounds per square inch).

#### c. Inlet Design

- (1) Screens shall be used to filter debris from runoff flowing into the storage unit.

#### d. Emergency Overflow

- (1) A positive outlet for overflow shall be provided a few inches from the top of the storage unit and sized to safely discharge the peak flow from the 10-year design storm when the storage unit is full.
- (2) Above-ground storage units shall have a release mechanism to drain and empty the unit between storm events.

## L. Vegetated Roof

### 1. Summary

Description:	Provides stormwater treatment and storage with a surface overflow.
Application:	Most practical for flat rooftops.
Types:	Intensive (> 4 inches, wide variety of plants, public use); Extensive (≤ 4 inches, plants are herbs, mosses, succulents and grasses).
Pretreatment Required:	No. This BMP can provide pretreatment.
Maintenance Plan:	Yes.
Calculation Credits:	
Volume Reduction:	Count subsurface storage volume below the overflow (limited by design rainfall on roof).
Rate Reduction:	Adjust time-of-concentration by dividing storage volume by 10-year peak inflow rate.
Water Quality:	Count subsurface storage volume.

### 2. Sizing Calculations

- For water quality, the minimum subsurface storage volume shall be equal to the volume from 1-inch of rain falling on the roof area.
- For channel protection, the subsurface storage volume below the overflow may be counted as retention.
- Calculate the subsurface storage volume of the BMP:

$$\text{Subsurface Storage Volume (cubic feet)} = \text{Length (feet)} \times \text{Width (feet)} \times \text{Depth (feet)} \times \text{Void Ratio of Material.}$$

### 3. Design Requirements

- Configuration: Follow manufacturer’s and structural engineer’s guidelines.
- Emergency Overflow: A positive outlet for overflow shall be provided.

### 4. Design Schematics

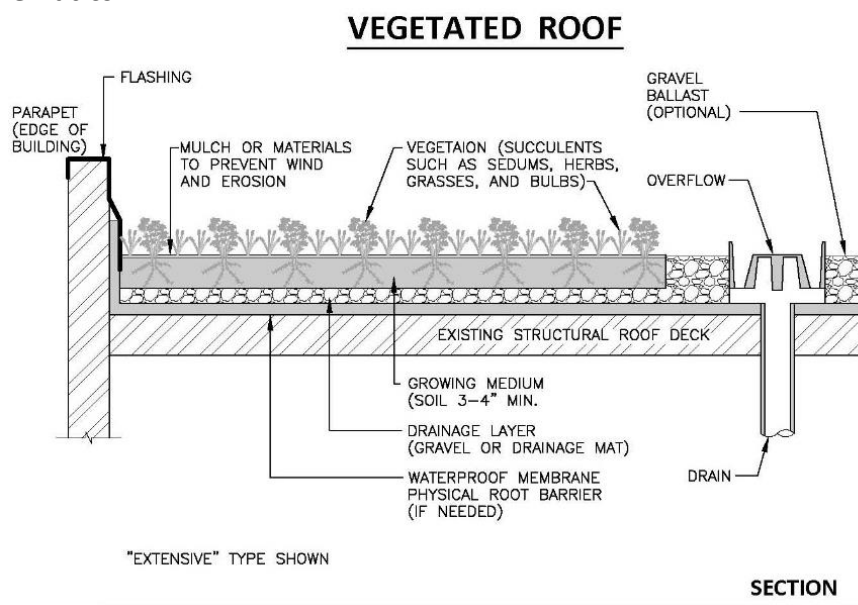

## M. Water Quality Device

### 1. Summary

Description:	Stormwater treatment unit.
Application:	Practical for small sites and drainage areas.
Types:	Oil and grit separator; Hydrodynamic separator.
Pretreatment Required:	No. This BMP can provide pretreatment and spill containment
Maintenance Plan:	Yes.
Calculation Credits:	
Volume Reduction:	None.
Rate Reduction:	None.
Water Quality:	Count volume routed through BMP.

### 2. Sizing Calculations

- a. Select water quality device unit/model based on manufacturer's recommendations.
- b. When the device is used to provide spill containment, the minimum spill containment volume shall be provided between the normal water level and the entrance of the outlet pipe to capture a slug pollutant load from an accidental spill of toxic materials.

### 3. Design Requirements

- a. Configuration
  - (1) The geometry of the water quality device shall promote the trapping of floatables and sediments.
  - (2) The water quality device shall be designed to prevent surcharging in pipes upstream of the device.
- b. Emergency Overflow
  - (1) A bypass overflow shall be designed to convey the 10-year peak discharge at a minimum without release of trapped sediments and pollutants.
  - (2) The outlet from the overflow shall not be submerged under normal conditions.

## N. Sediment Forebay

### 1. Summary

Description:	Stormwater pretreatment practice.
Application:	Typically used with a detention or retention basin.
Types:	Wet basin; Dry basin; Level spreader.
Pretreatment Required:	No. This BMP can provide pretreatment.
Maintenance Plan:	Yes.
Calculation Credits:	
Volume Reduction:	None.
Rate Reduction:	None.
Water Quality:	Count volume routed through BMP.

### 2. Sizing Calculations

- a. Size for pretreatment (refer to Part 4 section “Calculating Storage Volumes and Release Rates, Pretreatment”).
- b. The pretreatment volume is the volume of the forebay to the elevation of the level spreader or overflow spillway including any permanent pool.

### 3. Design Requirements

- a. Siting
  - (1) Where more than one inlet pipe is required, the calculated forebay volume shall be pro-rated by flow contribution of each inlet.
- b. Configuration
  - (1) The sediment forebay shall be a separate sump, which can be formed by grading.
  - (2) The minimum surface area shall be 25% of the pretreatment volume.
  - (3) The length-to-width ratio shall be a minimum of 1.5:1 and a maximum of 4:1 to allow for adequate hydraulic length yet minimize scour velocities.
  - (4) The top-of-berm elevation between the forebay and the basin shall be a minimum of 1 foot below the outer berm elevation.
  - (5) The overflow spillway shall be sized using Equation 4.23 and designed to prevent erosion.

### 4. Design Schematics

- a. See “Detention Basin” and “Retention Basin” BMPs.



## O. Spill Containment Cell

### 1. Summary

Description:	Lined stormwater pretreatment practice.
Application:	Typically used with a detention or retention basin.
Types:	Wet cell; Extended detention cell.
Pretreatment Required:	No. This BMP can provide pretreatment and spill containment.
Maintenance Plan:	Yes.
Calculation Credits:	
Volume Reduction:	None.
Rate Reduction:	None.
Water Quality:	Count volume routed through BMP.

### 2. Sizing Calculations

- a. Size for pretreatment (refer to Part 4 section “Calculating Storage Volumes and Release Rates, Pretreatment”).
- b. The pretreatment volume is the volume of the spill containment cell to the elevation of the level spreader or overflow spillway including any permanent pool.
- c. The spill containment volume is the storage volume between the normal water level and the entrance of the outlet pipe. The minimum spill containment volume shall be provided to capture a slug pollutant load from an accidental spill of toxic materials.

### 3. Design Requirements

- a. Siting
  - (1) All inlets shall enter the spill containment cell unless the inlet collects stormwater exclusively from non-hotspot areas (i.e. office parking, courtyard, roof.)
- b. Configuration
  - (1) General
    - (a.) The minimum surface area shall be 25% of the pretreatment volume.
    - (b.) The length-to-width ratio shall be a minimum of 1.5:1, and a maximum of 4:1 to allow for adequate hydraulic length yet minimize scour velocities.
    - (c.) The top-of-berm elevation between the spill containment cell and the basin shall be a minimum of 1 foot below the outer berm elevation.
    - (d.) Side slopes shall not be steeper than 4:1 (H:V).
    - (e.) Minimum depth of the permanent pool shall be 3 feet.
    - (f.) The permanent pool shall have two safety benches, each a minimum of 2 feet in width at a maximum slope of 10%. The first bench shall be located 1 foot above the permanent pool level; the second bench shall be located 1 foot below the permanent pool level.

## c. Outlet Design

- (1) The outlet structure from the spill containment cell shall be designed to draw water from the central portion of the water column within the cell to trap floatables and contain sediments. The inlet of the transfer pipe shall be located a minimum of 1 foot below the normal water level, and a minimum of 1 foot above the bottom of the spill containment cell or manhole sump.
- (2) The transfer pipe(s) between the spill containment cell and the basin shall be sized for the peak inflow from a 10-year rainfall event.
- (3) Minimum pipe diameter shall be 12 inches.

## d. Emergency Overflow

- (1) The crest of the level spreader or overflow spillway from the spill containment cell shall be set 0.1 feet above the calculated 10-year hydraulic head.
- (2) The overflow spillway from the spill containment cell shall be sized using Equation 4.23 and designed to prevent erosion.

## e. Materials

- (1) The spill containment cell shall be lined with impermeable materials extending up to the design high water elevation. A minimum 18-inch-thick clay layer, or an impermeable liner protected with a minimum 12 inches of soil cover are acceptable alternatives. Maximum allowable permeability shall be  $1 \times 10^{-7}$  centimeters per second as determined by the geotechnical consultant for clay placement, or manufacturer's certificate for liner products.

4. Design Schematics

**SPILL CONTAINMENT CELL**

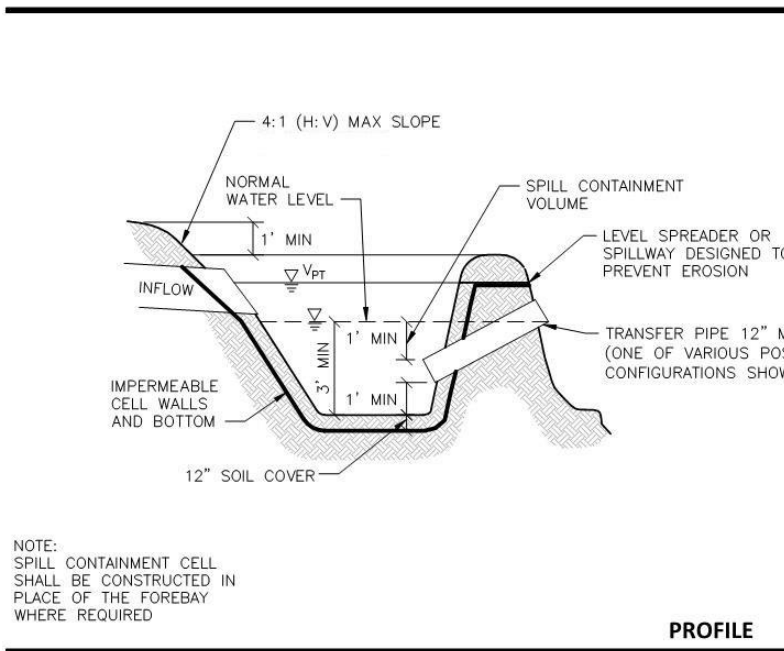
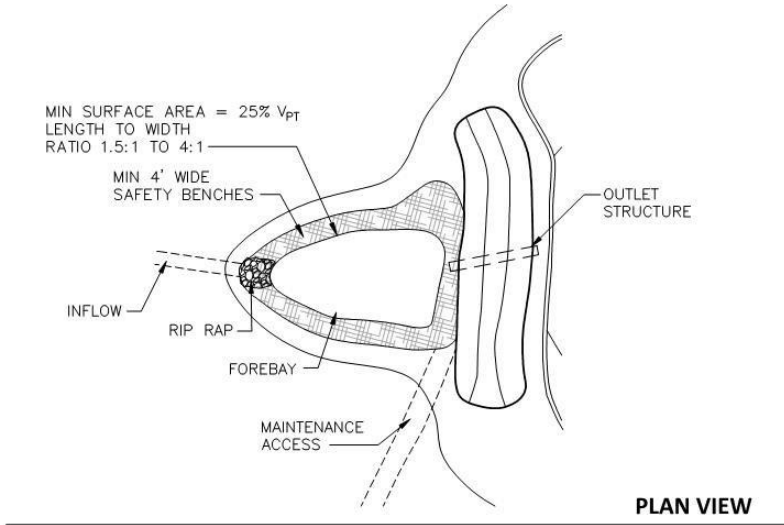

## P. Bioswale and Water Quality Swale

### 1. Summary

Description:	Bioswale: Vegetated swale designed to capture and treat stormwater within a dry storage layer beneath the base of the channel. Water Quality Swale: Lined swale designed to provide spill containment.
Application:	Bioswale: Linear projects or areas. Water Quality Swale: Small sites in lieu of a spill containment cell when a permanent pool is not desirable.
Types:	Dry swale; Swale with check dams.
Pretreatment Required:	No. This BMP can provide pretreatment and spill containment.
Maintenance Plan:	Yes.
Calculation Credits:	
Volume Reduction:	Bioswale: Count volume stored and infiltrated.
Rate Reduction:	Adjust time-of-concentration by dividing storage volume by 10-year peak flow rate.
Water Quality:	Bioswale: Count volume stored and infiltrated, or routed through filter. Water Quality Swale: Count volume routed through filter.

### 2. Sizing Calculations

- Size for pretreatment (refer to Part 4 section “Calculating Storage Volumes and Release Rates, Pretreatment”).
- The pretreatment volume is the volume of the voids within the filter media including any temporary surface storage volume to the elevation of the overflow, and including any permanent pool within the outlet structure.
- The spill containment volume is the storage volume between the normal water level in the filter and the entrance of the outlet pipe. The minimum spill containment volume shall be provided to capture a slug pollutant load from an accidental spill of toxic materials.
- Depth of surface ponding shall be no more than 2 feet and drain within 24 hours. Use Equation 4.25 and **Table 14** from “Constructed Filter” to calculate drain time.
- The swale shall be designed to pass the 10-year peak discharge with a minimum of 6-inches of freeboard to the top of bank.
- Volume Behind Check Dam (if used with bioswale)

(1) Calculate the wedge shaped storage volume behind each check dam:

$$\text{Storage Volume (cubic feet)} = 0.5 \times \text{Length of Swale Impoundment Area per Check Dam (feet)} \times \text{Depth of Check Dam (feet)} \times [\text{Top Width of Check Dam (feet)} + \text{Bottom Width of Check Dam (feet)}] / 2$$

### 3. Design Requirements

- Siting

- (1) All inlets shall enter the water quality swale unless the inlet collects stormwater exclusively from non-hotspot areas (i.e. office parking, courtyard, roof).
- b. Configuration
- (1) The bottom of the water quality swale shall be flat to encourage uniform ponding and filtration. Bioswales shall have a maximum longitudinal slope of 1%.
  - (2) The swale shall have a minimum bottom width of 2 feet and a maximum bottom width of 10 feet.
  - (3) Side slopes shall be 4:1 (H:V) or flatter.
  - (4) Sand filter shall have a minimum depth of 18 inches and a maximum depth of 36 inches.
  - (5) Stone bedding shall consist of at least 2 inches under the pipe and 4 inches above the pipe. An aggregate window extending to the filter surface may also be provided as a factor-of-safety.
  - (6) Underdrains shall have a 4-inch minimum pipe diameter.
  - (7) All underground pipes shall have clean-outs accessible from the surface.
  - (8) Pipes shall be sloped to prevent siltation.
- c. Check Dam Design
- (1) Check dams may be used along bioswales to encourage ponding and infiltration.
  - (2) Check dams shall be earthen or other impervious design. Rock check dams are not suitable for infiltration.
  - (3) Maximum ponding depth behind check dams shall be 24 inches.
  - (4) Minimum top width of earthen check dam shall be 2 feet.
  - (5) Check dams shall be keyed into the bottom and sides of the swale a minimum of 1-foot on all sides. The height of the key must exceed the 10-year water surface elevation by a minimum of 6 inches on both sides.
  - (6) The center of the check dam crest must be below the sides of the check dam by a minimum of 12 inches.
  - (7) The crest of a downstream check dam shall be no lower than the downstream toe of the upstream check dam.
  - (8) Erosion control measures (i.e. riprap, turf reinforcement mat) shall be used to protect the integrity of the check dam and downstream toe.
- d. Inlet Design
- (1) Inlet pipes shall require energy dissipation. Riprap protection or equivalent erosion control measures shall be used where the velocity exceeds 4 feet per second up to a maximum allowable design velocity of 8 feet per second.
- e. Outlet Design
- (1) The containment structure shall be constructed within a manhole and be designed to draw water from the central portion of the water column within the manhole to trap floatables and contain sediments in a minimum 3-foot sump.
  - (2) The swale shall be designed to pass the 10-year peak discharge.
- f. Overflow

- (1) A positive outlet for overflow shall be provided.
- (2) A catch basin and outlet pipe may be used to convey the 10-year peak discharge. In a water quality swale, this must be a separate structure, or chamber within the containment manhole to prevent the captured low-density fluids from becoming entrained in the water when surface inflow enters the structure.

g. Materials

- (1) Top Dressing
  - (a.) Native or imported permeable soil (sand and gravel); or where turf establishment is desired
  - (b.) 3-inches of compost tilled into the top 6-inches of native permeable soil (equivalent to a 9-inch homogenous mixture of 70% sand; 30% compost); or
  - (c.) 4-inches of topsoil tilled into the top 6-inches of native permeable soil (equivalent to a 10-inch homogenous mixture with maximum 20% silts, 4% clay, and 80% to 92% sand).
  - (d.) The soil mix shall have a pH between 5.5 and 7.5.
  - (e.) Topsoil shall be sandy loam, loamy sand or loam per USDA Soil Textural Triangle with 20% to 50% fines by volume (silt and clay with <10% clay), and 2% to 8% organic matter by dry weight.
- (2) Stone bedding shall consist of clean, uniformly graded coarse aggregate.
- (3) A woven geotextile fabric or 2-inch gravel choker course shall be placed between the sand and the stone bedding.
- (4) The water quality swale shall be lined with impermeable materials extending up to the design high water elevation. A minimum 18-inch-thick clay layer, or an impermeable liner protected with a minimum 12-inches of soil cover are acceptable alternatives. Maximum allowable permeability shall be  $1 \times 10^{-7}$  centimeters per second as determined by the geotechnical consultant for clay placement, or manufacturer's certificate for liner products.

4. Design Schematics

**BIOSWALE**

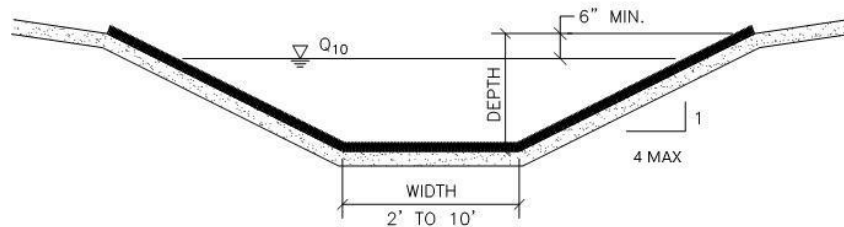

**SECTION**

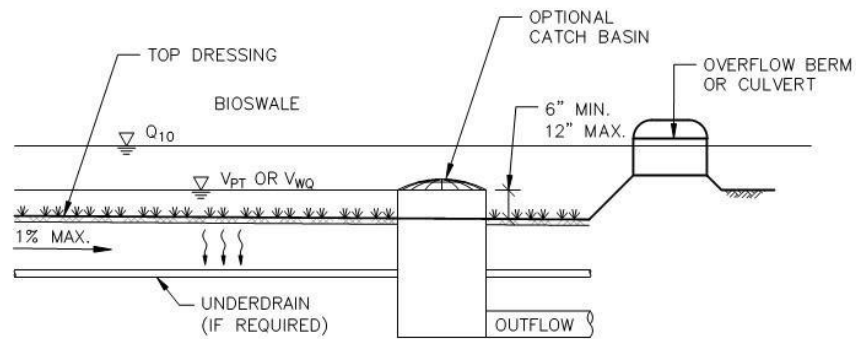

**PROFILE**

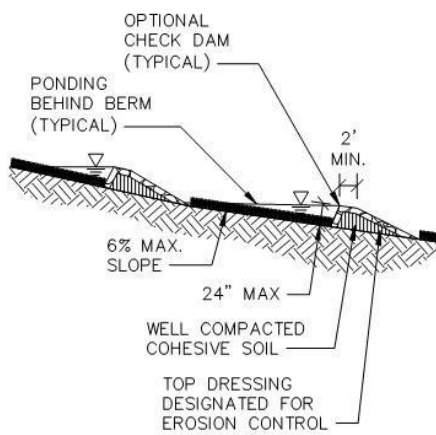

**CHECK DAM PROFILE**

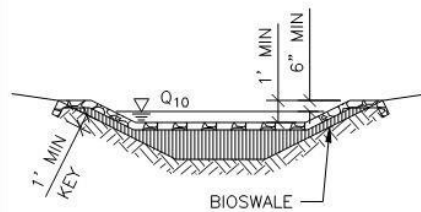

**CHECK DAM DETAIL**

## WATER QUALITY SWALE

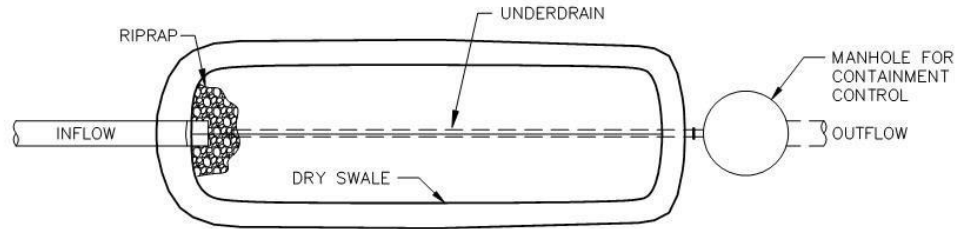

**PLAN VIEW**

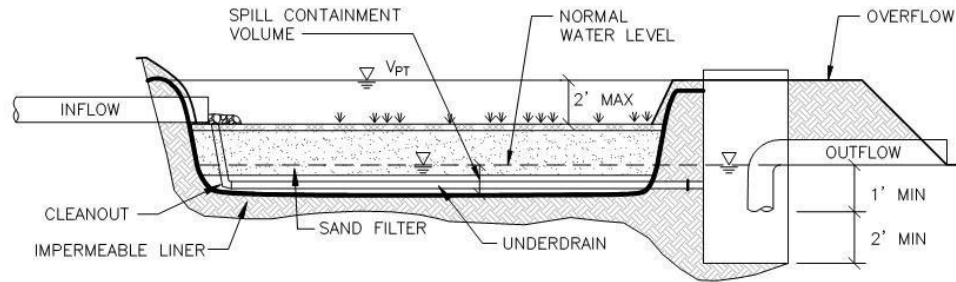

**PROFILE**

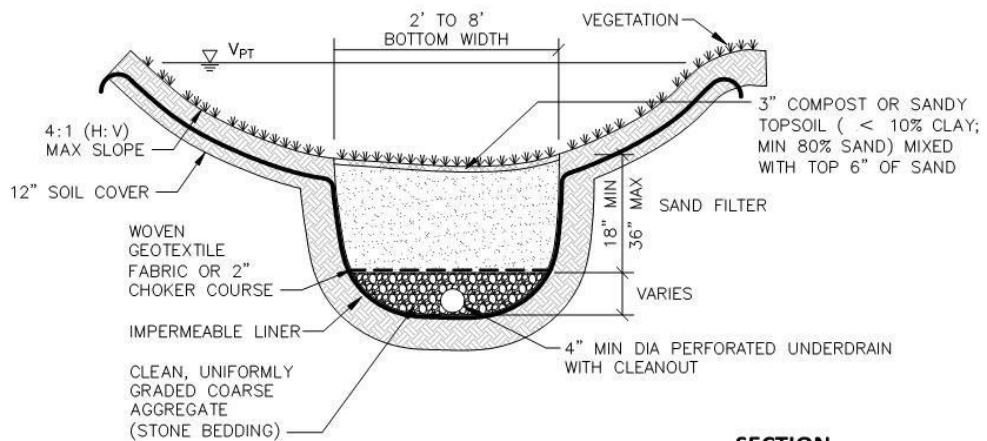

**SECTION**



## Q. Vegetated Swale

### 1. Summary

Description:	Stormwater conveyance designed to slow and filter stormwater.
Application:	Small drainage areas with concentrated flow.
Types:	Dry swale; Swale with check dams.
Pretreatment Required:	No. This BMP provides pretreatment.
Maintenance Plan:	Yes.
Calculation Credits:	
Volume Reduction:	None.
Rate Reduction:	Due to longer time-of-concentration for swale.
Water Quality:	Count volume routed through BMP.

### 2. Sizing Calculations

#### a. Channel

- (1) If used for pretreatment, refer to minimum standards in Part 3 section “Pretreatment.”
- (2) The vegetated swale shall be sized to pass the 10-year peak flow.
- (3) Calculate 10-year peak flow rate (refer to Part 4 section “Calculating Runoff”).
- (4) Size swale using Manning’s Equation:

$$Q = \frac{1.49AR^{\frac{2}{3}}S^{\frac{1}{2}}}{n} \tag{4.21}$$

where:

$Q$  = discharge (cubic feet per second)

$A$  = wetted area (square feet)

$R$  = hydraulic radius (feet)

$S$  = slope (feet per foot)

$n$  = Manning’s roughness coefficient

- (5) Select the higher value of Manning’s roughness coefficient from **Table 12** or **Figure 3** below.

**Figure 3 – Manning’s Roughness Coefficients for Vegetated Swales**

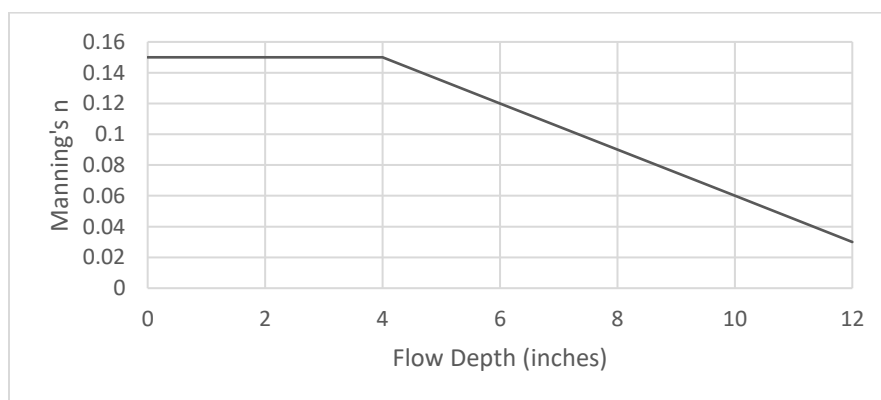

Source: SEMCOG (2008). *Low Impact Development Manual for Michigan*, Figure 7.62.

(6) Check that flow velocities are within acceptable limits. The minimum velocity for open channels shall be 1.5 feet per second. The maximum velocity shall be 4 feet per second.

b. Volume Behind Check Dam (if used)

(1) Calculate the wedge-shaped storage volume behind each check dam:

$$\text{Storage Volume (cubic feet)} = 0.5 \times \text{Length of Swale Impoundment Area per Check Dam (feet)} \times \text{Depth of Check Dam (feet)} \times [\text{Top Width of Check Dam (feet)} + \text{Bottom Width of Check Dam (feet)}] / 2$$

**3. Design Requirements**

a. Siting

- (1) Vegetated swales can be used for drainage areas up to 5 acres. Drainage areas greater than this may require open channels.
- (2) Minimum surface area to meet water quality standard by vegetative filtering:
  - (a.) The maximum bottom width to depth ratio for the water quality discharge shall be 12:1, or approximately equal to the grass height.
  - (b.) Minimum length per **Figures 4a** through **4d**.

b. Configuration

- (1) Trapezoidal, with a minimum bottom width of 2 feet and a maximum bottom width of 8 feet.
- (2) Side slopes shall be 4:1 (H:V) or flatter.
- (3) Longitudinal slope shall be a minimum of 1% and a maximum of 6%. Flatter slopes may be allowed on permeable soils.

c. Check Dam Design

- (1) Check dams may be used along vegetated swales with longitudinal slopes greater than 3%, or to encourage ponding and infiltration on flatter slopes.
- (2) Maximum ponding depth behind check dams shall be 18 inches.
- (3) Check dams shall be keyed into the bottom and sides of the swale a minimum of 1-foot on all sides. The height of the key must exceed the 10-year water surface elevation by a minimum of 6 inches on both sides.
- (4) The center of the check dam crest must be below the sides of the check dam by a minimum of 12 inches.
- (5) The crest of a downstream check dam shall be no lower than the downstream toe of the upstream check dam.

d. Materials

(1) Establishment of vegetation shall follow the guidelines outlined in **Table 15**.

**Table 15 – Permanent Stabilization Treatment for Vegetated Swales**

Swale Bottom Treatment	Swale Grade
Seed and Mulch	0.3% to 0.5%
Standard Mulch Blanket	0.5% to 1.5%
High Velocity Mulch Blanket or Sod	1.5% to 3.0%
Turf Reinforcement Mat or Check Dams	3.0% to 6.0%
Specific Design Required	> 6.0%

Source: Michigan Department of Transportation Drainage Manual (2006).

4. Design Schematics

**VEGETATED SWALE**

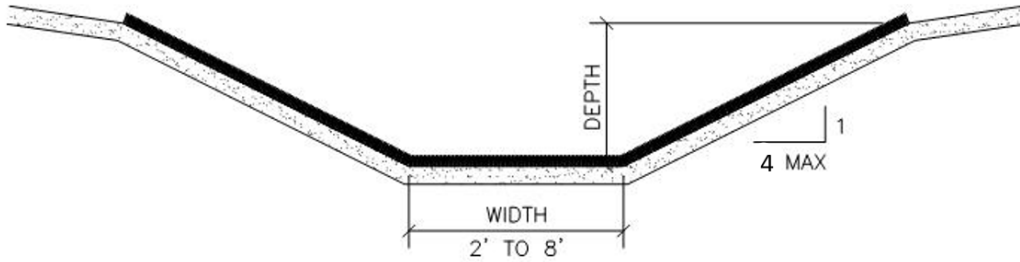

**SECTION**

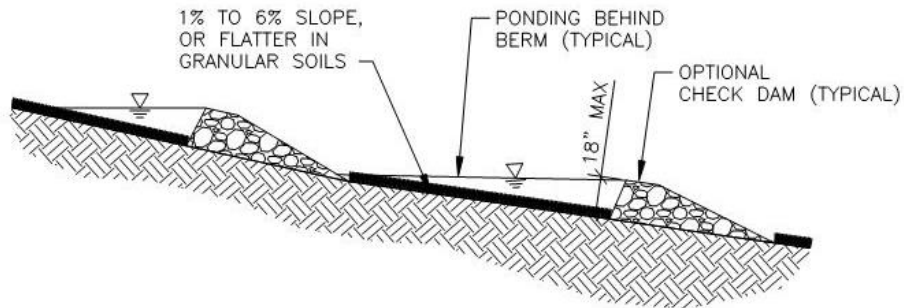

**PROFILE**

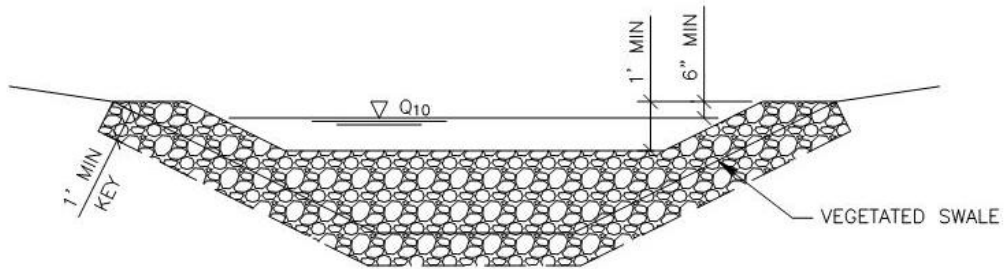

**CHECK DAM DETAIL**

## R. Vegetated Filter Strip

### 1. Summary

Description:	Overland flow path designed to slow and filter stormwater.
Application:	Contributing drainage areas with sheet flow surface runoff.
Types:	Turf grass; other dense herbaceous groundcover vegetation.
Pretreatment Required:	No. This BMP provides pretreatment.
Maintenance Plan:	Yes.
Calculation Credits:	
Volume Reduction:	None.
Rate Reduction:	Adjust time-of-concentration.
Water Quality:	

### 2. Sizing Calculations

- a. If used for pretreatment, refer to minimum standards in Part 3 section “Pretreatment.”
- b. Calculate the minimum required filter strip area by the equation:

$$A_{fs} = \frac{A}{6} \quad (4.27)$$

where:

$A_{fs}$  = area of filter strip (square feet)

$A$  = contributing drainage area (square feet)

*Note:* This equates to a loading ratio of 0.17 from the contributing drainage area (both impervious and pervious surfaces).

- c. Calculate minimum required longitudinal length based on slope and type of vegetation using the graphs in **Figures 4a** through **4d**.

### 3. Design Requirements

- a. Siting
  - (1) Maximum upstream drainage area shall generally be 100 feet impervious or 200 feet pervious upgradient.
- b. Configuration
  - (1) The upstream edge of the filter strip shall be level and at an elevation at least 1 inch below the adjacent pavement.
  - (2) A level spreader may also be required to evenly distribute flow across filter strip.
  - (3) Slopes shall range from a minimum of 1% to a maximum of 8%. Optimal slopes range from 2% to 6%.
  - (4) The maximum lateral slope shall be 1%.
  - (5) Berms and curbs may be installed along the sides of the filter strip parallel to the direction of flow to prohibit runoff from laterally bypassing the filter strip.

Figure 4a – Filter Strip Length (Sandy soils with HSG A)

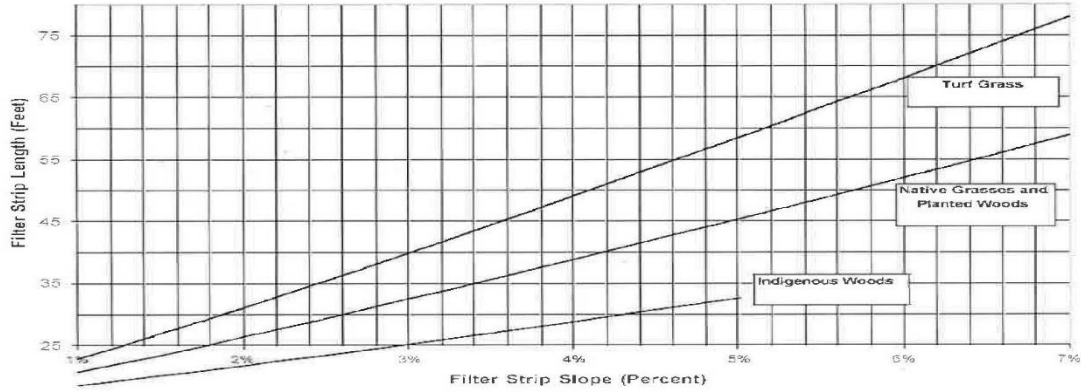

Figure 4b1 – Filter Strip Length (Sandy Loam soils with HSG B)

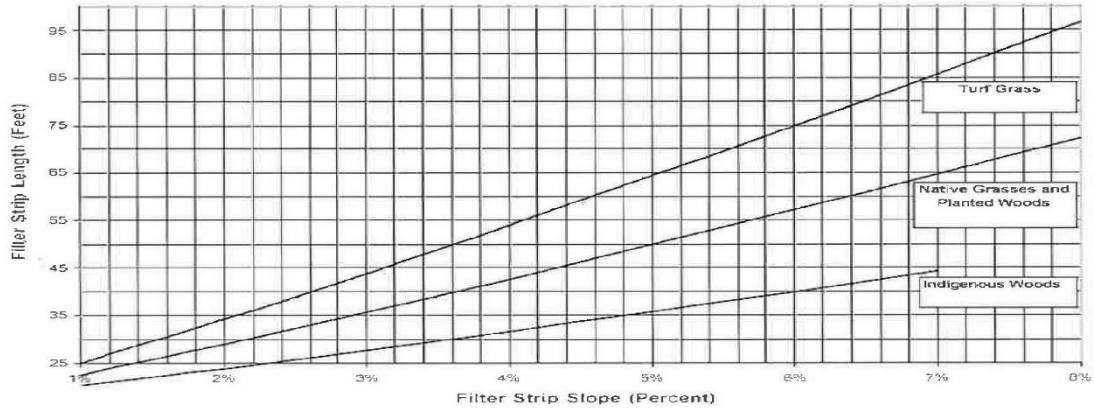
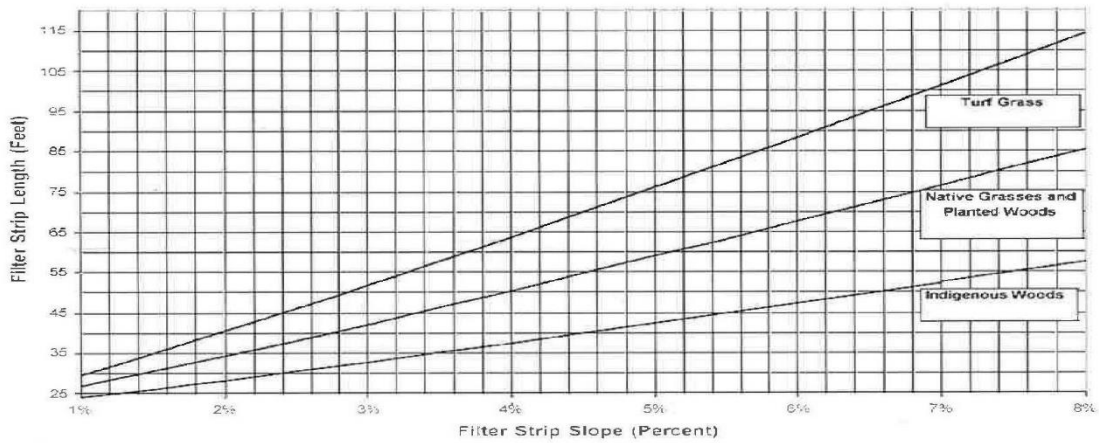

Figure 4b2 – Filter Strip Length (Loam, Silt-Loam soils with HSG B)



Source: SEMCOG (2008), *Low Impact Development Manual for Michigan*, Figures 7.52, 7.53 and 7.54 (New Jersey Stormwater Best Management Practices Manual, 2004)

Figure 4c – Filter Strip Length (Sandy Clay Loam soils with HSG C)

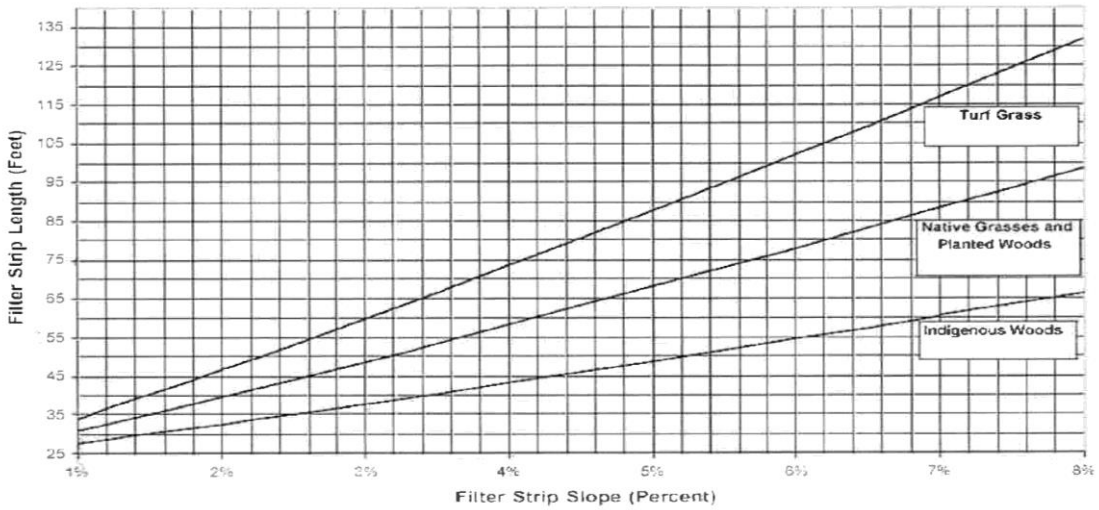
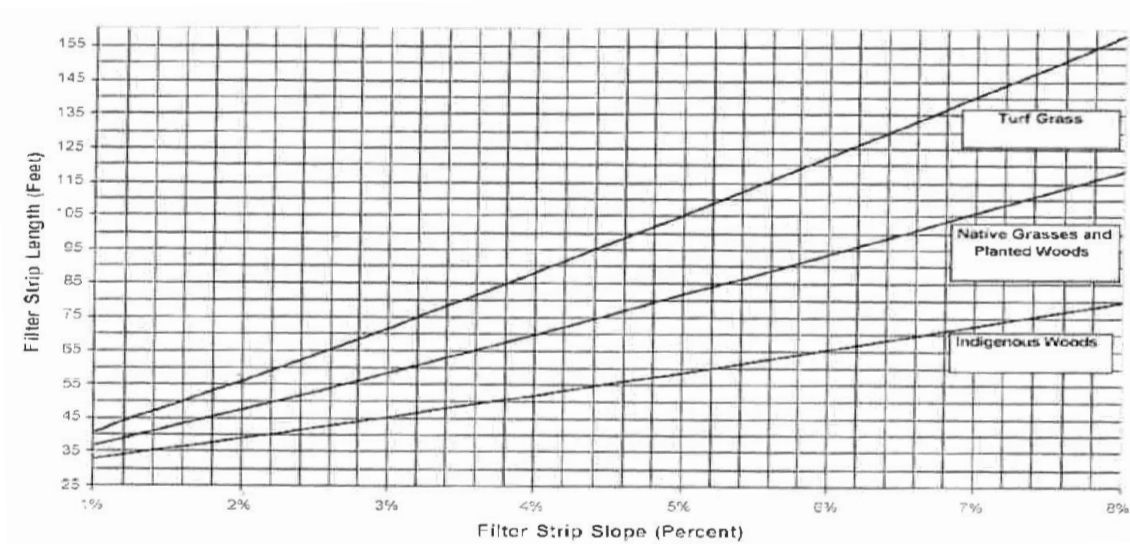

Figure 4d – Filter Strip Length (Clay Loam, Silty Clay, Clay soils with HSG D)



Source: SEMCOG (2008), *Low Impact Development Manual for Michigan*, Figures 7.55 and 7.56 (New Jersey Stormwater Best Management Practices Manual, 2004)

4. Design Schematics

**VEGETATED FILTER STRIP**

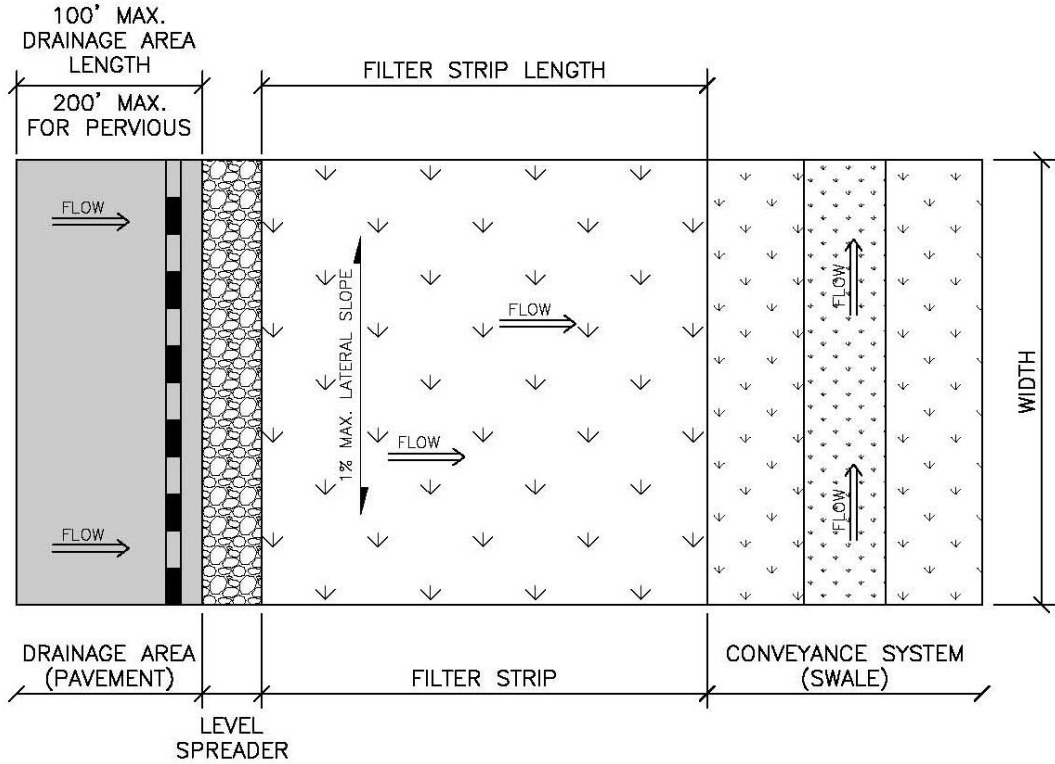

MIN. FILTER STRIP AREA = 1/6 DRAINAGE AREA.

**PLAN VIEW**

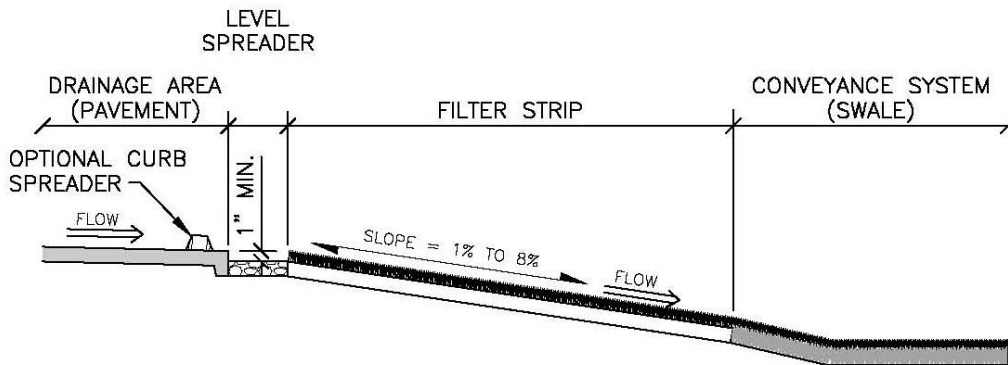

**PROFILE**

## S. Level Spreader

### 1. Summary

Description:	Shallow, level berm placed perpendicular to a flow path.
Application:	Used with other BMPs to disperse concentrated stormwater flows.
Types:	Inflow (prior to BMP); Outflow (at outlet of BMP).
Pretreatment Required:	No. This BMP provides pretreatment.
Maintenance Plan:	Yes.
Calculation Credits:	
Volume Reduction:	None.
Rate Reduction:	None.
Water Quality:	None.

### 2. Sizing Calculations

- a. The level spreader shall be sized to pass the 10-year peak flow.
- b. Calculate 10-year peak flow rate (refer to Part 4 section “Calculating Runoff”).

### 3. Design Requirements

- a. Siting
  - (1) Slopes below outflow level spreaders should be no greater than 8% in the direction of flow to discourage channelization.
- b. Configuration
  - (1) Construct level spreaders in compacted fill or of other non-erodible material.
  - (2) Minimum length: 10 feet.
  - (3) A bypass may be required for higher flows.
- c. Material
  - (1) Level spreaders may be constructed of compacted earth, rock, stone, concrete, treated timber or perforated pipe in stone.